

COMBI® 607 LG

Junction box 110x110x66mm, polypropylene, RAL 7035

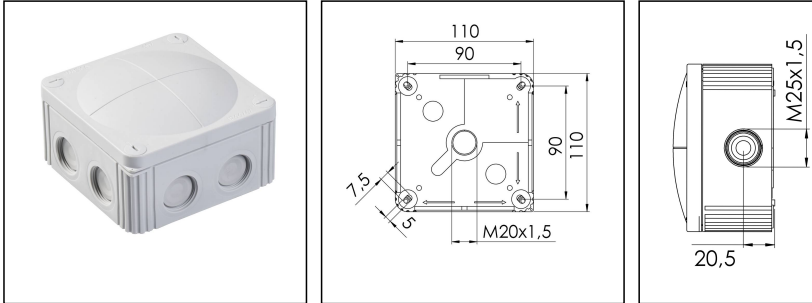

Products may differ in size, colour and appearance to those shown. If you require further information or customisation, please contact us directly.



Material	Polypropylene
Material sealing gasket	TPE
Temp. range min	-30 °C
Temp. range max	100 °C
Temperatures during install.	-5 °C - 60 °C
Protection class	IP66 / IP67
Glow wire test	750 °C
Voltage	690 V
Rated cross section	6 mm ²
Fixing	4 internal openings
Ø cable diameter min	5,2 mm
Ø cable diameter max	17 mm
External dimensions LxWxH	110 x 110 x 66mm
Using for cable gland	
Product Color	RAL 7035
WISKA-Order no.	10060531
Type	COMBI® 607 LG
Packing unit	3
ETIM-Classification	EC002600

Remarks:

IP66: using the membrane entry

Ø cable: 5,2 - 17 mm

IP67: using the threaded entry together with ESKV cable gland

Ø cable: 9,0 - 17 mm

Your Contact:

WISKA Hoppmann GmbH

Kisdorfer Weg 28 · 24568 Kaltenkirchen · Germany

☎ +49-4191-508-0 · 📠 +49-4191-508-209

contact@wiska.de · www.wiska.com

Mounting:

- 4 internal openings outside of the sealing area

Equipment:

- 7 elastic, self-sealing puncture-membranes for cable entry on the side and 3 on the bottom
- 7 integrated M25 thread for mounting without lock nut
- 4 captive cover screws

Recommended accessories

DIN Rail Kit - COMBI® 607	10060361
MP-L Mounting plate large COMBI® / WHK	10105775
External mounting - COMBI®	10108836
SP-HKT 607 Terminal block	22000407

15.10.2019

Your Contact:

WISKA Hoppmann GmbH

Kisdorfer Weg 28 · 24568 Kaltenkirchen · Germany

☎ +49-4191-508-0 · 📠 +49-4191-508-209

contact@wiska.de · www.wiska.com

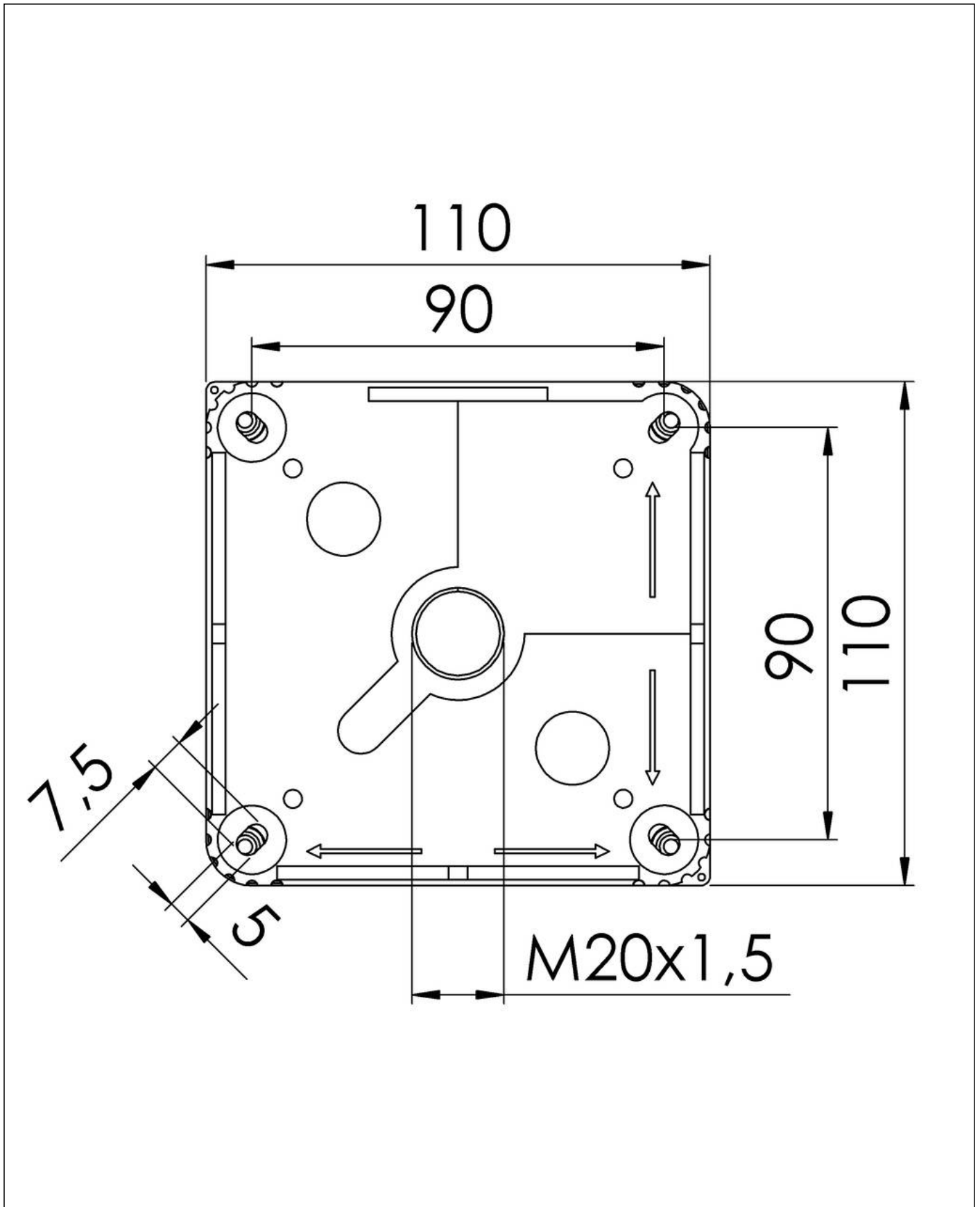

Your Contact:

WISKA Hoppmann GmbH

Kisdorfer Weg 28 · 24568 Kaltenkirchen · Germany

☎ +49-4191-508-0 · 📠 +49-4191-508-209

contact@wiska.de · www.wiska.com



Your Contact:

WISKA Hoppmann GmbH

Kisdorfer Weg 28 · 24568 Kaltenkirchen · Germany

☎ +49-4191-508-0 · 📠 +49-4191-508-209

contact@wiska.de · www.wiska.com