

# Short form

ENCLOSED SWITCHES

SWITCH DISCONNECTORS

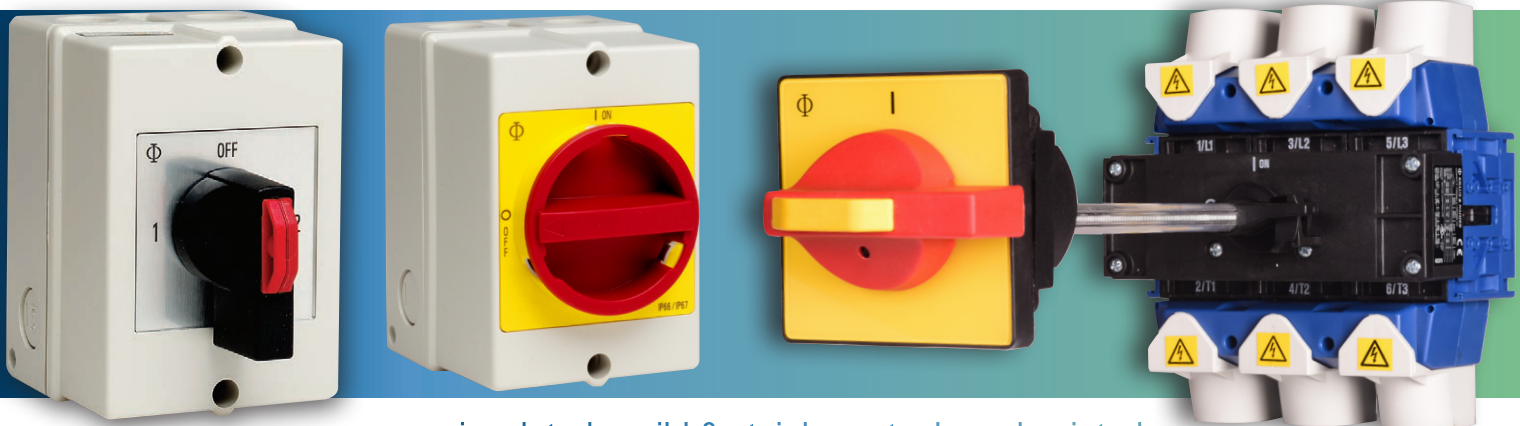

- grp
- insulated
- mild & stainless steel
- red painted
- photovoltaic
- isolating switches
- main/emergency off
- changeover

[krausnaimer.co.uk](http://krausnaimer.co.uk)

For free expert advice call our sales team **01635 262626** SF04/2019

# Short form

The Shorform Catalogue contains both our most popular  
**enclosed switches (pages 4-30)**

and our best selling panel mounted  
**switch disconnecter range (pages 31-47)**

Kraus & Naimer's Blue Line products are accepted and  
universally recognised for their quality and workmanship.

Kraus & Naimer Limited is part of the worldwide  
Kraus & Naimer Group which celebrated its 110 year anniversary in 2017.

In 1963, Kraus & Naimer Limited was established as the UK sales and marketing  
company for Kraus & Naimer switchgear. By the early 70's successful growth meant  
a move to its current purpose-built premises in Newbury, where it supplies over 3,000  
customers with world-renowned, high quality Blue Line switchgear products.

Our key to success is the outstanding level of technical product support through  
our dedicated team of internal and external technical sales engineers. With many  
years experience, training and unbeatable product knowledge the team can find a  
solution for your switch applications

Please note for orders under £150 net, a carriage charge of £10 is added.

**[www.krausnaimer.co.uk](http://www.krausnaimer.co.uk)**  
**e: [sales-uk@krausnaimer.com](mailto:sales-uk@krausnaimer.com) t: 01635 262626**

# ENCLOSED PRODUCTS

## Contents

Page

### Enclosed Switch Disconnectors

#### Main & Main/Emergency-Off Switch

Insulated enclosure	4-5
Painted mild steel enclosure	6-7
Red painted mild steel enclosure	8-9
Stainless steel enclosure	10-11
Sloping roof stainless	12-13
Flush mounted stainless	14-15
GRP enclosure	14-15
GRP defeatable door interlock	16-17
Insulated enclosure, EMC compliant connection	16-17
GRP all-in-one	18

#### Main/Emergency-Off Switch + Emergency Stop Push Button

Insulated enclosure/painted mild steel enclosure/stainless steel enclosure	19
--	----

#### Changeover Switch with Centre Off

Insulated, painted mild steel & stainless steel enclosure	20-21
GRP enclosure	22-23
Load switch, painted mild steel	22-23

### AC/DC Switch-disconnectors for Photovoltaic

#### AC Switch-Disconnectors

Single & three phase	25 - 40A	24
----------------------	----------	----

#### DC Switch-Disconnectors

Single string & two string	8 - 50A up to 1000VDC	25
----------------------------	-----------------------	----

### Control Switches

#### Emergency Stop Push Button Station

Stainless steel enclosure	twist to reset, key operate to reset	26
Painted steel enclosure	twist to reset, key operate to reset	
Stainless steel, flush mount	twist to reset, key operate to reset	
Insulated enclosure	twist to reset, pull to reset palm/foot switch	

#### Emergency Stop Push Button Station with protective shroud

Stainless steel enclosure	twist to reset, key operate to reset	27
Painted steel enclosure	twist to reset, key operate to reset	
Stainless steel, flush mount	twist to reset, key operate to reset	
Insulated enclosure	twist to reset, pull to reset palm/foot switch	

#### Fire Alarm Isolator

Insulated enclosure - double pole 10A	26-27
---------------------------------------	-------

#### Rotary Control Switch

Insulated enclosure off/on & changeover switches	28
--	----

#### Key Operated Control Switch

Insulated enclosure off/on, changeover & step switches	28
--	----

### Load Switches

#### Emergency-Off Switch

Insulated enclosure 3 & 4 pole	25A & 32A	28
--------------------------------	-----------	----

#### Motor Reversing Switch

Insulated enclosure 3 phase/1 phase motors	28
--	----

### Technical Data & Additional Information

#### Options & Additional Information

Technical data	29
IP rating information	30

# SWITCH DISCONNECTORS

Contents Page	31
Products & Technical data	32-47

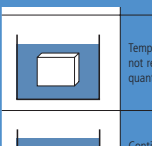

# OFF-ON / SWITCH DISCONNECTORS



Main/Emergency-Off Switch

20A - 315A

3, 4, 6 & 8 POLE



**IP RATING** IP66/67 protection

**ENCLOSURE** insulated polycarbonate grey (RAL7035)

**HANDLE OPTION** red & yellow padlockable handle  
optional black handle available

**EARTH TERMINAL** included

**SAFETY FEATURE** switch is interlocked with the lid to prevent opening in 'ON' position

Without Auxiliaries	le AC-21A	3 Pole	Encl. Ref		3 Pole + Solid Neutral (TP&N)	Encl. Ref		
	20A	KG10 T203/GBA270 *KS1V	KSAV		KG10 T203/GBA355 *KS1V	KSAV		
	25A	KG20 T203/GBA270 *KS1V	KSAV		KG20 T203/GBA355 *KS1V	KSAV		
	32A	KG32 T203/GBA270 *KS1V	KSAV		KG32 T203/GBA355 *KS1V	KSAV		
	40A	KG41 T203/GBA270 *KL1V	KLCV		KG41 T203/GBA355 *KL1V	KLCV		
	63A	KG64 T203/GBA270 *KL1V	KLCV		KG64 T203/GBA355 *KL1V	KLCV		
	80A	KG80 T203/GBA270 *KL1V	KLDV		KG80 T203/GBA355 *KL1V	KLDV		
	100A	KG100 T203/GBA270 *KL1V	KLDV		KG100 T203/GBA355 *KL1V	KLDV		
	125A	KG105 T203/GBA270 *KL1V	KLDV		KG105 T203/GBA355 *KL1V	KLDV		
	125A <sup>3)</sup>	KG125 T203/GBA270 *ST	ST3		KG125 T207/GBA355 *ST	ST3		
160A	KG160 T203/GBA270 *ST	ST3		KG160 T207/GBA355 *ST	ST3			
200A	KG210 T203/GBA270 *ST	ST3		KG210 T207/GBA355 *ST	ST4			
250A	KG250 T203/GBA270 *ST	ST3		KG250 T207/GBA355 *ST	ST4			
315A	KG315 T203/GBA270 *ST	ST3		KG315 T207/GBA355 *ST	ST4			

With Auxiliaries 1	le AC-21A	3 Pole + Aux	Encl. Ref		3 Pole + Solid Neutral (TP&N) + Aux	Encl. Ref		
	20A	KG10 T203/GBA281 *KS1V	KSAV		KG10 T203/GBA374 *KS1V	KSAV		
	25A	KG20 T203/GBA280 *KS1V	KSAV		KG20 T203/GBA373 *KS1V	KSAV		
	32A	KG32 T203/GBA280 *KS1V	KSAV		KG32 T203/GBA373 *KS1V	KSAV		
	40A	KG41 T203/GBA280 *KL1V	KLCV		KG41 T203/GBA373 *KL1V	KLCV		
	63A	KG64 T203/GBA280 *KL1V	KLCV		KG64 T203/GBA373 *KL1V	KLCV		
	80A	KG80 T203/GBA280 *KL1V	KLDV		KG80 T203/GBA373 *KL1V	KLDV		
	100A	KG100 T203/GBA280 *KL1V	KLDV		KG100 T203/GBA373 *KL1V	KLDV		
	125A	KG105 T203/GBA280 *KL1V	KLDV		KG105 T203/GBA373 *KL1V	KLDV		
	125A <sup>3)</sup>	KG125 T203/GBA065 *ST	ST3		KG125 T207/GBA110 *ST	ST3		
160A	KG160 T203/GBA065 *ST	ST3		KG160 T207/GBA110 *ST	ST3			
200A	KG210 T203/GBA070 *ST	ST3		KG210 T207/GBA120 *ST	ST4			
250A	KG250 T203/GBA070 *ST	ST3		KG250 T207/GBA120 *ST	ST4			
315A	KG315 T203/GBA070 *ST	ST3		KG315 T207/GBA120 *ST	ST4			

## Notes

1) The following auxiliary contacts are provided:-

KG10 3 to 6 Pole	1 N.O. (early break) + 1 N.C.
KG20 to KG105 3 to 6 Pole	2 N.O. (early break)
KG10 to KG100 8 Pole	1 N.O. (early break) + 1 N.C.
KG125 to KG315 3 to 8 Pole	2 N.O. (early break) + 2 N.C.

2) Switched neutral pole is early make/late break.

3) KG125 suitable for applications requiring larger cable termination and increased enclosure size.



## DIMENSIONS (units= mm throughout the catalogue unless stated otherwise)

Encl. Ref.	Encl. Dim.			Encl. Dim.			Cable Entries.	Line Drg.
	H	W	D	H1	W1	d		
KSAV	120	85	90	110	-	4.2	4 x 20/25mm k'outs	Fig. 1
KLCV	190	100	93	178	-	5.6	4 x 20/25mm k'outs	Fig. 1
KLD	250	145	107	229	124	6.5	4 x 25/40mm k'outs	Fig. 2
KLDV	250	145	107	229	124	6.5	4 x 25/40mm k'outs	Fig. 2
STE	280	190	180	254	164	7	2 x gland plates	Fig. 2
ST2	280	190	130	254	164	7	2 x gland plates	Fig. 2
ST3	380	280	180	354	254	7	2 x gland plates	Fig. 2
ST4	560	380	180	534	354	7	2 x gland plates	Fig. 2

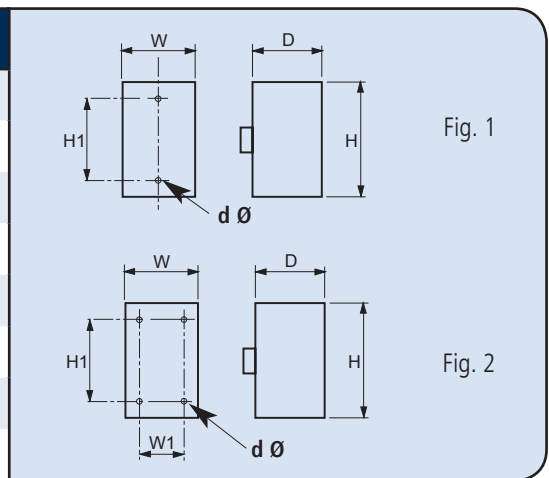

Please refer to end of part no. for enclosure reference. See tables below:

4 Pole (3ph + Sw N²)		Encl. Ref.	6 Pole		Encl. Ref.	le AC-21A
KG10	T204/GBA290 *KS1V	KSAV	KG10B	T206/GBA320 *KS1V	KSAV	20A
KG20	T204/GBA290 *KS1V	KSAV	KG20B	T206/GBA320 *KL1V	KLCV	25A
KG32	T204/GBA290 *KS1V	KSAV	KG32B	T206/GBA320 *KL1V	KLCV	32A
KG41	T204/GBA290 *KL1V	KLCV	KG41B	T206/GBA320 *KL1V	KLDV	40A
KG64	T204/GBA290 *KL1V	KLCV	KG64B	T206/GBA320 *KL1V	KLDV	63A
KG80	T204/GBA290 *KL1V	KLDV	KG80	T206/GBA967 *ST	STE	80A
KG100	T204/GBA290 *KL1V	KLDV	KG100	T206/GBA967 *ST	STE	100A
KG105	T204/GBA290 *KL1V	KLDV	KG105	T206/GBA967 *ST	STE	125A
KG125	T204/GBA290 *ST	ST3	KG125	T206/GBA967 *ST	ST4	125A <sup>3)</sup>
KG160	T204/GBA290 *ST	ST3	KG160	T206/GBA967 *ST	ST4	160A
KG210	T204/GBA290 *ST	ST4				200A
KG250	T204/GBA290 *ST	ST4				250A
KG315	T204/GBA290 *ST	ST4				315A

4 Pole (3ph + Sw N²) + Aux		Encl. Ref.	6 Pole + Aux		Encl. Ref.	8 Pole (2x3ph + Sw N²) + Aux		Encl. Ref.	le AC-21A
KG10	T204/GBA311 *KS1V	KSAV	KG10	T206/40 *KS51V	KSAV	KG10	T208/GBA002 *KS1V	KSAV	20A
KG20	T204/GBA310 *KS1V	KSAV	KG20B	T206/GBA330 *KL1V	KLCV	KG20B	T208/GBA008 *KL	KLD	25A
KG32	T204/GBA310 *KS1V	KSAV	KG32B	T206/GBA330 *KL1V	KLCV	KG32B	T208/GBA008 *KL	KLD	32A
KG41	T204/GBA310 *KL1V	KLCV	KG41B	T206/GBA330 *KL1V	KLDV	KG41B	T208/GBA008 *ST	ST2	40A
KG64	T204/GBA310 *KL1V	KLCV	KG64B	T206/GBA330 *KL1V	KLDV	KG64B	T208/GBA008 *ST	ST2	63A
KG80	T204/GBA310 *KL1V	KLDV	KG80	T206/GBA907 *ST	STE	KG80	T208/GBA008 *ST	ST3	80A
KG100	T204/GBA310 *KL1V	KLDV	KG100	T206/GBA907 *ST	STE	KG100	T208/GBA008 *ST	ST3	100A
KG105	T204/GBA310 *KL1V	KLDV	KG105	T206/GBA907 *ST	STE				125A
KG125	T204/GBA075 *ST	ST3	KG125	T206/GBA085 *ST	ST4	KG125	T208/GBA010 *ST	ST4	125A <sup>3)</sup>
KG160	T204/GBA075 *ST	ST3	KG160	T206/GBA085 *ST	ST4	KG160	T208/GBA010 *ST	ST4	160A
KG210	T204/GBA080 *ST	ST4							200A
KG250	T204/GBA080 *ST	ST4							250A
KG315	T204/GBA080 *ST	ST4							315A

# OFF-ON / SWITCH DISCONNECTORS



**Main/Emergency-Off Switch**

**20A - 315A**

**3, 4, 6, 9 & 12 POLE**



**IP RATING** IP66 protection

**ENCLOSURE** grey paint finish (RAL7032)

**HANDLE OPTION** red & yellow padlockable handle  
optional black handle available

**EARTH TERMINAL** included + lid bonding link

**SAFETY FEATURE** switch is interlocked with the lid to prevent opening in 'ON' position

Without Auxiliaries	le AC-21A	3 Pole		3 Pole + Solid Neutral (TP&N)		4 Pole (3ph + Sw N <sup>2</sup> )	
	20A	KG10 T203/GBA119 *MB2				KG10 T204/GBA219 *MB2	
	25A	KG20 T203/GBA119 *MB2		KG20 T207/GBA170 *MB2		KG20 T204/GBA219 *MB2	
	32A	KG32 T203/GBA119 *MB2		KG32 T207/GBA170 *MB2		KG32 T204/GBA219 *MB2	
	40A	KG41 T203/GBA109 *MB2		KG41 T207/GBA170 *MB2		KG41 T204/GBA209 *MB2	
	63A	KG64 T203/GBA109 *MB2		KG64 T207/GBA170 *MB2		KG64 T204/GBA209 *MB2	
	80A	KG80 T203/GBA109 *MB3		KG80 T207/GBA170 *MB3		KG80 T204/GBA209 *MB3	
	100A	KG100 T203/GBA109 *MB3		KG100 T207/GBA170 *MB3		KG100 T204/GBA209 *MB3	
	125A	KG105 T203/GBA109 *MB3		KG105 T207/GBA170 *MB3		KG105 T204/GBA209 *MB3	
	125A <sup>3)</sup>	KG125 T203/GBA109 *MB8		KG125 T207/GBA170 *MB8		KG125 T204/GBA209 *MB8	
160A	KG160 T203/GBA109 *MB8		KG160 T207/GBA170 *MB8		KG160 T204/GBA209 *MB8		
200A	KG210 T203/GBA109 *MB9		KG210 T207/GBA170 *MB9		KG210 T204/GBA209 *MB9		
250A	KG250 T203/GBA109 *MB9		KG250 T207/GBA170 *MB9		KG250 T204/GBA209 *MB9		
275A							
315A	KG315 T203/GBA109 *MB9		KG315 T207/GBA170 *MB9		KG315 T204/GBA209 *MB9		

With Auxiliaries <sup>1</sup>	le AC-21A	3 Pole + Aux		3 Pole + Solid Neutral (TP&N)+Aux		4 Pole (3ph + Sw N <sup>2</sup> ) + Aux	
	20A	KG10 T203/GBA168 *MB2				KG10 T204/GBA268 *MB2	
	25A	KG20 T203/GBA169 *MB2		KG20 T207/GBA175 *MB2		KG20 T204/GBA269 *MB2	
	32A	KG32 T203/GBA169 *MB2		KG32 T207/GBA175 *MB2		KG32 T204/GBA269 *MB2	
	40A	KG41 T203/GBA159 *MB2		KG41 T207/GBA175 *MB2		KG41 T204/GBA259 *MB2	
	63A	KG64 T203/GBA159 *MB2		KG64 T207/GBA175 *MB2		KG64 T204/GBA259 *MB2	
	80A	KG80 T203/GBA159 *MB3		KG80 T207/GBA175 *MB3		KG80 T204/GBA259 *MB3	
	100A	KG100 T203/GBA159 *MB3		KG100 T207/GBA175 *MB3		KG100 T204/GBA259 *MB3	
	125A	KG105 T203/GBA159 *MB3		KG105 T207/GBA175 *MB3		KG105 T204/GBA259 *MB3	
	125A <sup>3)</sup>	KG125 T203/GBA165 *MB8		KG125 T207/GBA180 *MB8		KG125 T204/GBA265 *MB8	
160A	KG160 T203/GBA165 *MB8		KG160 T207/GBA180 *MB8		KG160 T204/GBA265 *MB8		
200A	KG210 T203/GBA175 *MB9		KG210 T207/GBA185 *MB9		KG210 T204/GBA275 *MB9		
250A	KG250 T203/GBA175 *MB9		KG250 T207/GBA185 *MB9		KG250 T204/GBA275 *MB9		
275A							
315A	KG315 T203/GBA175 *MB9		KG315 T207/GBA185 *MB9		KG315 T204/GBA275 *MB9		

## Main Switches 250A - 1250A 3 & 4 POLE (IP65 with black & red padlockable handle)

With Auxiliaries <sup>1</sup>	le AC-21A	3 Pole + Aux		3 Pole + Neutral Link + Aux		4 Pole + Aux	
	250A	UK250/A 3011ST02 *MB25		UK250/A 3111ST02 *MB25		UK250/A 4011ST02 *MB25	
	315A	UK315/A 3011ST02 *MB26		UK315/A 3111ST02 *MB26		UK315/A 4011ST02 *MB26	
	400A	UK400/A 3011ST02 *MB26		UK400/A 3111ST02 *MB26		UK400/A 4011ST02 *MB26	
	630A	UK630/A 3011ST02 *MB27		UK630/A 3111ST02 *MB27		UK630/A 4011ST02 *MB27	
	800A	UK800/A 3011ST02 *MB28		UK800/A 3111ST02 *MB28		UK800/A 4011ST02 *MB28	
	1000A	UK1000/A 3011ST02 *MB28		UK1000/A 3111ST02 *MB28		UK1000/A 4011ST02 *MB28	
	1250A	UK1250/A 3011ST02 *MB28		UK1250/A 3111ST02 *MB28		UK1250/A 4011ST02 *MB28	



Encl. Ref.	Encl. Dim.				Encl. Dim.			Cable Entries.	Line Drg.
	H	W	D	D1	H1	W1	d		
MB2	194	119	115	8	133	137	6	-	Fig. 4
MB3	254	149	125	8	193	167	6	-	Fig. 4
MB4	309	234	150	8	248	252	6	-	Fig. 4
MB8	400	300	175	-	340	240	6.5	2 x gland plates	Fig. 6
MB9	500	400	175	-	440	340	6.5	2 x gland plates	Fig. 6
MB10	500	400	300	-	440	340	6.5	2 x gland plates	Fig. 6
MB20	250	175	175	-	225	195	6	-	Fig. 4
MB25	650	450	225	-	590	390	6.5	2 x gland plates	Fig. 6
MB26	800	550	225	-	740	490	6.5	2 x gland plates	Fig. 6
MB27	900	600	300	-	840	540	6.5	2 x gland plates	Fig. 6
MB28	1000	800	400	-	940	740	6.5	4 x gland plates	Fig. 6
MB29	750	450	300	-	690	390	6.5	2 x gland plates	Fig. 6

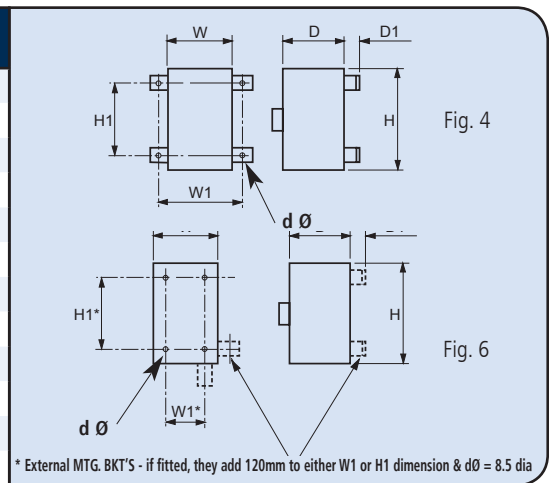

Please refer to end of part no. for enclosure reference. See tables below:

	6 Pole		9 Pole		12 Pole		Ie AC-21A
			UK 20/9000ST01 *MB20		UK 20/12000ST01 *MB20		20A
			UK 25/9000ST01 *MB20		UK 25/12000ST01 *MB20		25A
			UK 32/9000ST01 *MB20		UK 32/12000ST01 *MB20		32A
							40A
							63A
							80A
							100A
							125A
							125A <sup>3)</sup>
							160A
							200A
							250A
							275A
							315A

	6 Pole + Aux		9 Pole + Aux		12 Pole + Aux		Ie AC-21A
			UK 20/9020ST01 *MB20		UK 20/12020ST01 *MB20		20A
			UK 25/9020ST01 *MB20		UK 25/12020ST01 *MB20		25A
			UK 32/9020ST01 *MB20		UK 32/12020ST01 *MB20		32A
							40A
							63A
							80A
							100A
							125A
							125A <sup>3)</sup>
							160A
							200A
							250A
							275A
							315A

### Notes

- The following auxiliary contacts are provided:-
  - KG10 1 N.O. (early break) + 1 N.C.
  - KG20 to KG105 2 N.O. (early break)
  - KG125 to KG315 2 N.O. (early break) + 2 N.C.
  - UK20 to UK32 2 N.O. (early break)
  - C316/C200-4 2 N.O. (early break)
  - UK250/A to UK1250/A 1 N.O. (early break) + 1 N.C.

2) Switched neutral pole is early make/late break.

3) KG125 suitable for applications requiring larger cable termination and increased enclosure size.

# GET SEEN

see next page for RED  
enclosures - also available in BLACK

# OFF-ON / SWITCH DISCONNECTORS



**Main/Emergency-Off Switch**

**20A - 315A**

**3, 4, 6, 9 & 12 POLE**



**IP RATING**

IP66 protection

**ENCLOSURE**

red paint finish (RAL3000)

**HANDLE OPTION**

red and yellow padlockable handle  
optional black handle available

**EARTH TERMINAL**

included + lid bonding link

**SAFETY FEATURE**

switch is interlocked with the lid to prevent opening in 'ON' position

Without Auxiliaries	le AC-21A	3 Pole		3 Pole + Solid Neutral (TP&N)		4 Pole (3ph + Sw N <sup>2</sup> )	
	20A	KG10	T203/GBA119 *RB2			KG10	T204/GBA219 *RB2
	25A	KG20	T203/GBA119 *RB2	KG20	T207/GBA170 *RB2	KG20	T204/GBA219 *RB2
	32A	KG32	T203/GBA119 *RB2	KG32	T207/GBA170 *RB2	KG32	T204/GBA219 *RB2
	40A	KG41	T203/GBA109 *RB2	KG41	T207/GBA170 *RB2	KG41	T204/GBA209 *RB2
	63A	KG64	T203/GBA109 *RB2	KG64	T207/GBA170 *RB2	KG64	T204/GBA209 *RB2
	80A	KG80	T203/GBA109 *RB3	KG80	T207/GBA170 *RB3	KG80	T204/GBA209 *RB3
	100A	KG100	T203/GBA109 *RB3	KG100	T207/GBA170 *RB3	KG100	T204/GBA209 *RB3
	125A	KG105	T203/GBA109 *RB3	KG105	T207/GBA170 *RB3	KG105	T204/GBA209 *RB3
	125A <sup>3)</sup>	KG125	T203/GBA109 *RB8	KG125	T207/GBA170 *RB8	KG125	T204/GBA209 *RB8
160A	KG160	T203/GBA109 *RB8	KG160	T207/GBA170 *RB8	KG160	T204/GBA209 *RB8	
200A	KG210	T203/GBA109 *RB9	KG210	T207/GBA170 *RB9	KG210	T204/GBA209 *RB9	
250A	KG250	T203/GBA109 *RB9	KG250	T207/GBA170 *RB9	KG250	T204/GBA209 *RB9	
275A							
315A	KG315	T203/GBA109 *RB9	KG315	T207/GBA170 *RB9	KG315	T204/GBA209 *RB9	

With Auxiliaries <sup>1</sup>	le AC-21A	3 Pole + Aux		3 Pole + Solid Neutral (TP&N)+Aux		4 Pole (3ph + Sw N <sup>2</sup> ) + Aux	
	20A	KG10	T203/GBA168 *RB2			KG10	T204/GBA268 *RB2
	25A	KG20	T203/GBA169 *RB2	KG20	T207/GBA175 *RB2	KG20	T204/GBA269 *RB2
	32A	KG32	T203/GBA169 *RB2	KG32	T207/GBA175 *RB2	KG32	T204/GBA269 *RB2
	40A	KG41	T203/GBA159 *RB2	KG41	T207/GBA175 *RB2	KG41	T204/GBA259 *RB2
	63A	KG64	T203/GBA159 *RB2	KG64	T207/GBA175 *RB2	KG64	T204/GBA259 *RB2
	80A	KG80	T203/GBA159 *RB3	KG80	T207/GBA175 *RB3	KG80	T204/GBA259 *RB3
	100A	KG100	T203/GBA159 *RB3	KG100	T207/GBA175 *RB3	KG100	T204/GBA259 *RB3
	125A	KG105	T203/GBA159 *RB3	KG105	T207/GBA175 *RB3	KG105	T204/GBA259 *RB3
	125A <sup>3)</sup>	KG125	T203/GBA165 *RB8	KG125	T207/GBA180 *RB8	KG125	T204/GBA265 *RB8
160A	KG160	T203/GBA165 *RB8	KG160	T207/GBA180 *RB8	KG160	T204/GBA265 *RB8	
200A	KG210	T203/GBA175 *RB9	KG210	T207/GBA185 *RB9	KG210	T204/GBA275 *RB9	
250A	KG250	T203/GBA175 *RB9	KG250	T207/GBA185 *RB9	KG250	T204/GBA275 *RB9	
275A							
315A	KG315	T203/GBA175 *RB9	KG315	T207/GBA185 *RB9	KG315	T204/GBA275 *RB9	

**Main Switches 250A - 1250A 3 & 4 POLE (IP65 with black & red padlockable handle)**

With Auxiliaries <sup>1</sup>	le AC-21A	3 Pole + Aux		3 Pole + Neutral Link + Aux		4 Pole + Aux	
	250A	UK250/A	3011ST02 *RB25	UK250/A	3111ST02 *RB25	UK250/A	4011ST02 *RB25
	315A	UK315/A	3011ST02 *RB26	UK315/A	3111ST02 *RB26	UK315/A	4011ST02 *RB26
	400A	UK400/A	3011ST02 *RB26	UK400/A	3111ST02 *RB26	UK400/A	4011ST02 *RB26
	630A	UK630/A	3011ST02 *RB27	UK630/A	3111ST02 *RB27	UK630/A	4011ST02 *RB27
	800A	UK800/A	3011ST02 *RB28	UK800/A	3111ST02 *RB28	UK800/A	4011ST02 *RB28
	1000A	UK1000/A	3011ST02 *RB28	UK1000/A	3111ST02 *RB28	UK1000/A	4011ST02 *RB28
	1250A	UK1250/A	3011ST02 *RB28	UK1250/A	3111ST02 *RB28	UK1250/A	4011ST02 *RB28



# red painted mild steel enclosure



Encl. Ref.	H	Encl. Dim.			Encl. Dim.			Cable Entries.	Line Drg.
		W	D	D1	H1	W1	d		
RB2	194	119	115	8	133	137	6	-	Fig. 4
RB3	254	149	125	8	193	167	6	-	Fig. 4
RB4	309	234	150	8	248	252	6	-	Fig. 4
RB8	400	300	175	-	340	240	6.5	2 x gland plates	Fig. 6
RB9	500	400	175	-	440	340	6.5	2 x gland plates	Fig. 6
RB10	500	400	300	-	440	340	6.5	2 x gland plates	Fig. 6
RB20	250	175	175	-	225	195	6	-	Fig. 4
RB25	650	450	225	-	590	390	6.5	2 x gland plates	Fig. 6
RB26	800	550	225	-	740	490	6.5	2 x gland plates	Fig. 6
RB27	900	600	300	-	840	540	6.5	2 x gland plates	Fig. 6
RB28	1000	800	400	-	940	740	6.5	4 x gland plates	Fig. 6
RB29	750	450	300	-	690	390	6.5	2 x gland plates	Fig. 6

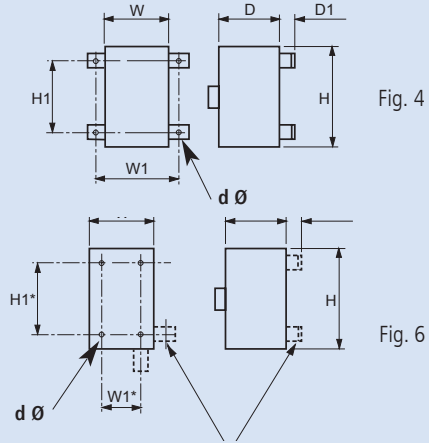

\* External MTG. BKT'S - if fitted, they add 120mm to either W1 or H1 dimension & dØ = 8.5 dia

Please refer to end of part no. for enclosure reference. See tables below:

	6 Pole		9 Pole		12 Pole		Ie AC-21A
			UK 20/9000ST01 *RB20		UK 20/12000ST01 *RB20		20A
KG20B	T206/GBA309 *RB2		UK 25/9000ST01 *RB20		UK 25/12000ST01 *RB20		25A
KG32B	T206/GBA309 *RB2		UK 32/9000ST01 *RB20		UK 32/12000ST01 *RB20		32A
KG41B	T206/GBA309 *RB3						40A
KG64B	T206/GBA309 *RB3						63A
KG80	T206/GBA309 *RB4						80A
KG100	T206/GBA309 *RB4						100A
KG105	T206/GBA309 *RB4						125A
KG125	T206/GBA309 *RB9						125A <sup>3)</sup>
KG160	T206/GBA309 *RB9						160A
C200-4	T206/GBA309 *RB10						200A
							250A
C316	T206/GBA309 *RB10						275A
C316	T206/GBA309 *RB29						315A

	6 Pole + Aux		9 Pole + Aux		12 Pole + Aux		Ie AC-21A
			UK 20/9020ST01 *RB20		UK 20/12020ST01 *RB20		20A
KG20B	T206/GBA359 *RB2		UK 25/9020ST01 *RB20		UK 25/12020ST01 *RB20		25A
KG32B	T206/GBA359 *RB2		UK 32/9020ST01 *RB20		UK 32/12020ST01 *RB20		32A
KG41B	T206/GBA359 *RB3						40A
KG64B	T206/GBA359 *RB3						63A
KG80	T206/GBA359 *RB4						80A
KG100	T206/GBA359 *RB4						100A
KG105	T206/GBA359 *RB4						125A
KG125	T206/GBA365 *RB9						125A <sup>3)</sup>
KG160	T206/GBA365 *RB9						160A
C200-4	T206/GBA385 *RB10						200A
							250A
C316	T206/GBA006 *RB10						275A
C316	T206/GBA365 *RB29						315A

## Notes

- 1) The following auxiliary contacts are provided:-
- KG10 1 N.O. (early break) + 1 N.C.
  - KG20 to KG105 2 N.O. (early break)
  - KG125 to KG315 2 N.O. (early break) + 2 N.C.
  - UK20 to UK32 2 N.O. (early break)
  - C316/C200-4 2 N.O. (early break)
  - UK250/A to UK1250/A 1 N.O. (early break) + 1 N.C.

2) Switched neutral pole is early make/late break.

3) KG125 suitable for applications requiring larger cable termination and increased enclosure size.

# OFF-ON / SWITCH DISCONNECTORS



**Main/Emergency-Off Switch 20A - 315A**

**3, 4 & 6 POLE**



**IP RATING** IP66 protection

**ENCLOSURE** brushed stainless steel, grade 316L

**HANDLE OPTION** red & yellow padlockable handle  
optional black handle available

**EARTH TERMINAL** included + lid bonding link

**FEATURE** switch is interlocked with the lid to prevent opening in 'ON' position

Without Auxiliaries	le AC-21A	3 Pole		3 Pole + Solid Neutral (TP&N)		4 Pole (3ph + Sw N <sup>2</sup> )	
	20A	KG10	T203/GBA419 *SB2			KG10	T204/GBA519 *SB2
	25A	KG20	T203/GBA419 *SB2	KG20	T207/GBA420 *SB2	KG20	T204/GBA519 *SB2
	32A	KG32	T203/GBA419 *SB2	KG32	T207/GBA420 *SB2	KG32	T204/GBA519 *SB2
	40A	KG41	T203/GBA409 *SB2	KG41	T207/GBA420 *SB2	KG41	T204/GBA509 *SB2
	63A	KG64	T203/GBA409 *SB2	KG64	T207/GBA420 *SB2	KG64	T204/GBA509 *SB2
	80A	KG80	T203/GBA409 *SB3	KG80	T207/GBA420 *SB3	KG80	T204/GBA509 *SB3
	100A	KG100	T203/GBA409 *SB3	KG100	T207/GBA420 *SB3	KG100	T204/GBA509 *SB3
	125A	KG105	T203/GBA409 *SB3	KG105	T207/GBA420 *SB3	KG105	T204/GBA509 *SB3
	125A <sup>3)</sup>	KG125	T203/GBA409 *SB8	KG125	T207/GBA420 *SB8	KG125	T204/GBA509 *SB8
160A	KG160	T203/GBA409 *SB8	KG160	T207/GBA420 *SB8	KG160	T204/GBA509 *SB8	
200A	KG210	T203/GBA409 *SB9	KG210	T207/GBA420 *SB9	KG210	T204/GBA509 *SB9	
250A	KG250	T203/GBA409 *SB9	KG250	T207/GBA420 *SB9	KG250	T204/GBA509 *SB9	
315A	KG315	T203/GBA409 *SB9	KG315	T207/GBA420 *SB9	KG315	T204/GBA509 *SB9	

With Auxiliaries <sup>1</sup>	le AC-21A	3 Pole + Aux		3 Pole + Solid Neutral (TP&N) + Aux		4 Pole (3ph + Sw N <sup>2</sup> ) + Aux	
	20A	KG10	T203/GBA468 *SB2			KG10	T204/GBA568 *SB2
	25A	KG20	T203/GBA469 *SB2	KG20	T207/GBA480 *SB2	KG20	T204/GBA569 *SB2
	32A	KG32	T203/GBA469 *SB2	KG32	T207/GBA480 *SB2	KG32	T204/GBA569 *SB2
	40A	KG41	T203/GBA459 *SB2	KG41	T207/GBA480 *SB2	KG41	T204/GBA559 *SB2
	63A	KG64	T203/GBA459 *SB2	KG64	T207/GBA480 *SB2	KG64	T204/GBA559 *SB2
	80A	KG80	T203/GBA459 *SB3	KG80	T207/GBA480 *SB3	KG80	T204/GBA559 *SB3
	100A	KG100	T203/GBA459 *SB3	KG100	T207/GBA480 *SB3	KG100	T204/GBA559 *SB3
	125A	KG105	T203/GBA459 *SB3	KG105	T207/GBA480 *SB3	KG105	T204/GBA559 *SB3
	125A <sup>3)</sup>	KG125	T203/GBA475 *SB8	KG125	T207/GBA490 *SB8	KG125	T204/GBA565 *SB8
160A	KG160	T203/GBA475 *SB8	KG160	T207/GBA490 *SB8	KG160	T204/GBA565 *SB8	
200A	KG210	T203/GBA485 *SB9	KG210	T207/GBA495 *SB9	KG210	T204/GBA575 *SB9	
250A	KG250	T203/GBA485 *SB9	KG250	T207/GBA495 *SB9	KG250	T204/GBA575 *SB9	
315A	KG315	T203/GBA485 *SB9	KG315	T207/GBA495 *SB9	KG315	T204/GBA575 *SB9	

## Main Switches 250A - 1250A 3 & 4 POLE (IP65 with black & red padlockable handle)

With Auxiliaries <sup>1</sup>	le AC-21A	3 Pole + aux		3 Pole + aux + Neutral Link		4 Pole + aux	
	250A	UK250/A	3011ST02 *SB25	UK250/A	3111ST02 *SB25	UK250/A	4011ST02 *SB25
	315A	UK315/A	3011ST02 *SB26	UK315/A	3111ST02 *SB26	UK315/A	4011ST02 *SB26
	400A	UK400/A	3011ST02 *SB26	UK400/A	3111ST02 *SB26	UK400/A	4011ST02 *SB26
	630A	UK630/A	3011ST02 *SB27	UK630/A	3111ST02 *SB27	UK630/A	4011ST02 *SB27
	800A	UK800/A	3011ST02 *SB28	UK800/A	3111ST02 *SB28	UK800/A	4011ST02 *SB28
	1000A	UK1000/A	3011ST02 *SB28	UK1000/A	3111ST02 *SB28	UK1000/A	4011ST02 *SB28
	1250A	UK1250/A	3011ST02 *SB28	UK1250/A	3111ST02 *SB28	UK1250/A	4011ST02 *SB28

# stainless steel enclosure



Encl. Ref.	H	Encl. Dim.			Encl. Dim.			Cable Entries.	Line Drg.
		W	D	D1	H1	W1	d		
SB2	194	119	116	-	133	137	6	-	Fig. 5
SB3	254	149	126	-	193	167	6	-	Fig. 5
SB4	309	234	151	-	248	252	6	-	Fig. 5
SB8	400	300	175	-	340	240	6.5	2 x gland plates	Fig. 6
SB9	500	400	175	-	440	340	6.5	2 x gland plates	Fig. 6
SB10	500	400	300	-	440	340	6.5	2 x gland plates	Fig. 6
SB25	650	450	225	-	590	390	6.5	2 x gland plates	Fig. 6
SB26	800	550	225	-	740	490	6.5	2 x gland plates	Fig. 6
SB27	900	600	300	-	840	540	6.5	2 x gland plates	Fig. 6
SB28	1000	800	400	-	940	740	6.5	4 x gland plates	Fig. 6
SB29	750	450	300	-	690	390	6.5	2 x gland plates	Fig. 6

Please refer to end of part no. for enclosure reference. See tables below:

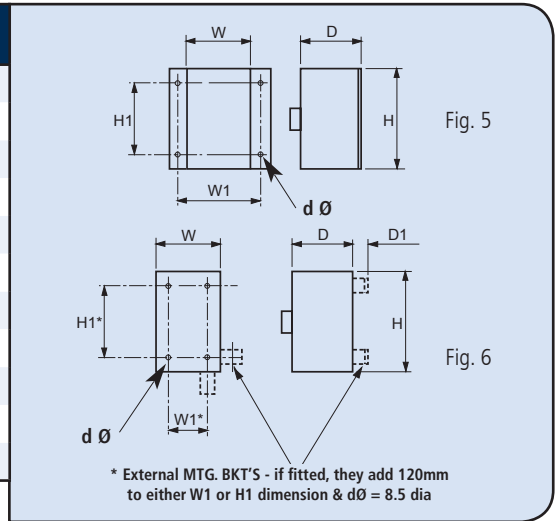

6 Pole		le AC-21A
KG20B	T206/GBA609 *SB2	20A
KG32B	T206/GBA609 *SB2	25A
KG41B	T206/GBA609 *SB3	32A
KG64B	T206/GBA609 *SB3	40A
KG80	T206/GBA609 *SB4	63A
KG100	T206/GBA609 *SB4	80A
KG105	T206/GBA609 *SB4	100A
KG125	T206/GBA609 *SB9	125A <sup>3)</sup>
KG160	T206/GBA609 *SB9	160A
C200-4	T206/GBA609 *SB10	200A
		250A
C316	T206/GBA609 *SB29	315A

6 Pole + Aux		le AC-21A
KG20B	T206/GBA659 *SB2	20A
KG32B	T206/GBA659 *SB2	25A
KG41B	T206/GBA659 *SB3	32A
KG64B	T206/GBA659 *SB3	40A
KG80	T206/GBA659 *SB4	63A
KG100	T206/GBA659 *SB4	80A
KG105	T206/GBA659 *SB4	100A
KG125	T206/GBA659 *SB4	125A
KG160	T206/GBA659 *SB9	125A <sup>3)</sup>
KG160	T206/GBA665 *SB9	160A
C200-4	T206/GBA003 *SB10	200A
		250A
C316	T206/GBA659 *SB29	315A

NEW PRODUCT

Kraus & Naimer

Stainless Steel Range

## Industrial interlocked Switch & Socket

- IP66
- 16Amp or 32Amp
- 3, 4 or 5 pin
- 2 N.O. (early break) Aux contacts

t: 01635 262626 e: sales-uk@krausnaimer.com

### Notes

- 1) The following auxiliary contacts are provided:-
 

KG10	1 N.O. (early break) + 1 N.C.
KG20 to KG105	2 N.O. (early break)
KG125 to KG315	2 N.O. (early break) + 2 N.C.
C316/C200-4	2 N.O. (early break)
UK250/A to UK1250/A	1 N.O. (early break) + 1 N.C.
- 2) Switched neutral pole is early make/late break.
- 3) KG125 suitable for applications requiring larger cable termination and increased enclosure size.

our extensive range of

# Switch-Disconnectors

doesn't just stop at 100A

# 20A-1250A

# OFF-ON / SWITCH DISCONNECTORS



**Main/Emergency-Off Switch**    **25A - 125A**    **3, 3 + Neutral & 4 POLE**



- IP RATING** IP65 protection
- ENCLOSURE** brushed stainless steel, grade 304L with integral canopy
- HANDLE OPTION** red & yellow padlockable handle optional black handle available
- SAFETY FEATURE** switch is interlocked with the lid to prevent opening in 'ON' position
- ADDITIONAL FEATURE** sloping roof

le AC-21A	Encl. Ref.	3 Pole +2 N.O. aux			3 Pole + solid neutral +2 N.O. aux		
20A	SR04	KG10	T203/GBA630 *SR04				
25A	SR04	KG20	T203/GBA630 *SR04		KG20	T207/GBA640 *SR04	
32A	SR04	KG32	T203/GBA630 *SR04		KG32	T207/GBA640 *SR04	
25A <sup>2</sup>	SR14	KG20	T203/GBA601 *SR14		KG20	T207/GBA603 *SR14	
32A <sup>2</sup>	SR14	KG32	T203/GBA601 *SR14		KG32	T207/GBA603 *SR14	
40A	SR14	KG41	T203/GBA601 *SR14		KG41	T207/GBA603 *SR14	
63A	SR14	KG64	T203/GBA601 *SR14		KG64	T207/GBA603 *SR14	
80A	SR24	KG80	T203/GBA601 *SR24		KG80	T207/GBA603 *SR24	
100A	SR24	KG100	T203/GBA601 *SR24		KG100	T207/GBA603 *SR24	
125A	SR24	KG105	T203/GBA601 *SR24		KG105	T207/GBA603 *SR24	

**Main/Emergency-Off Switch**    **25A - 125A**    **3, 3 + Neutral & 4 POLE**



- IP RATING** IP65 protection
- ENCLOSURE** brushed stainless steel, grade 304L, with integral canopy
- HANDLE OPTION** red & yellow padlockable handle optional black handle available
- SAFETY FEATURE** switch is interlocked with the lid to prevent opening in 'ON' position
- ADD. FEATURE** sloping roof with welded mounting plate

le AC-21A	Encl. Ref.	3 Pole +2 N.O. aux			3 Pole + solid neutral +2 N.O. aux		
20A	SR04L	KG10	T203/GBA660 *SR04L				
25A	SR04L	KG20	T203/GBA660 *SR04L		KG20	T207/GBA670 *SR04L	
32A	SR04L	KG32	T203/GBA660 *SR04L		KG32	T207/GBA670 *SR04L	
25A <sup>2</sup>	SR14L	KG20	T203/GBA601 *SR14L		KG20	T207/GBA603 *SR14L	
32A <sup>2</sup>	SR14L	KG32	T203/GBA601 *SR14L		KG32	T207/GBA603 *SR14L	
40A	SR14L	KG41	T203/GBA601 *SR14L		KG41	T207/GBA603 *SR14L	
63A	SR14L	KG64	T203/GBA601 *SR14L		KG64	T207/GBA603 *SR14L	
80A	SR24L	KG80	T203/GBA601 *SR24L		KG80	T207/GBA603 *SR24L	
100A	SR24L	KG100	T203/GBA601 *SR24L		KG100	T207/GBA603 *SR24L	
125A	SR24L	KG105	T203/GBA601 *SR24L		KG105	T207/GBA603 *SR24L	

# sloping roof - stainless steel enclosure



Encl. Ref.	Front Plate		Side View		
	H1	W1	D1	D2	H2
SR04	170	130	103	122	196
SR14	193	130	132	151	234
SR24	278	185	152	170	324

Please refer to end of part no. for enclosure reference. See table below:

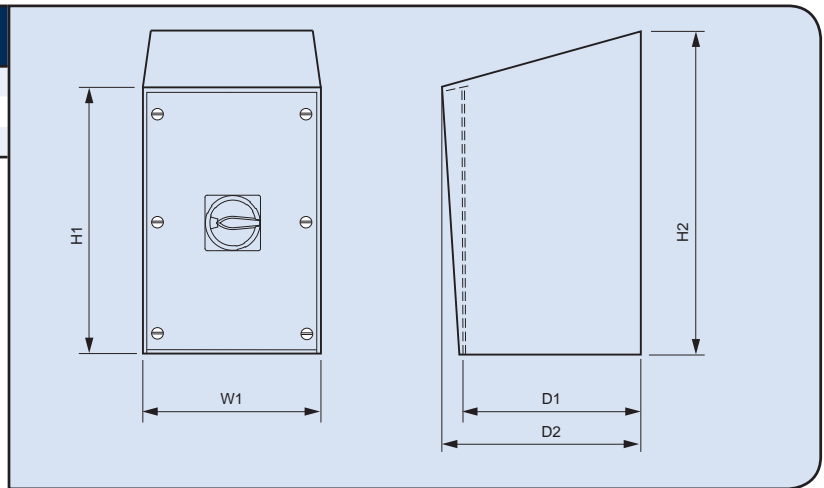

	4 Pole (3ph + Sw N <sup>1</sup> ) +2 N.O. aux		le AC-21A
KG10	T204/GBA650 *SR04		20A
KG20	T204/GBA650 *SR04		25A
KG32	T204/GBA650 *SR04		32A
KG20	T204/GBA602 *SR14		25A <sup>2</sup>
KG32	T204/GBA602 *SR14		32A <sup>2</sup>
KG41	T204/GBA602 *SR14		40A
KG64	T204/GBA602 *SR14		63A
KG80	T204/GBA602 *SR24		80A
KG100	T204/GBA602 *SR24		100A
KG105	T204/GBA602 *SR24		125A

The 15° sloping roof deflects water and prevents items from being placed on top of the enclosure, making it easier and safer to clean

**Note** 1) Switched neutral pole is early make/late break.  
2) Larger enclosure size (SR14)

Encl. Ref.	Front View			
	H1	W1	W2	W3
SR04L	171	130	155	180
SR14L	209	130	155	180
SR24L	299	185	210	260

Encl. Ref.	Side View		
	H2	D1	D2
SR04L	196	104.2	123.2
SR14L	234	133.2	152.2
SR24L	324	153.2	171.2

Please refer to end of part no. for enclosure reference. See table below:

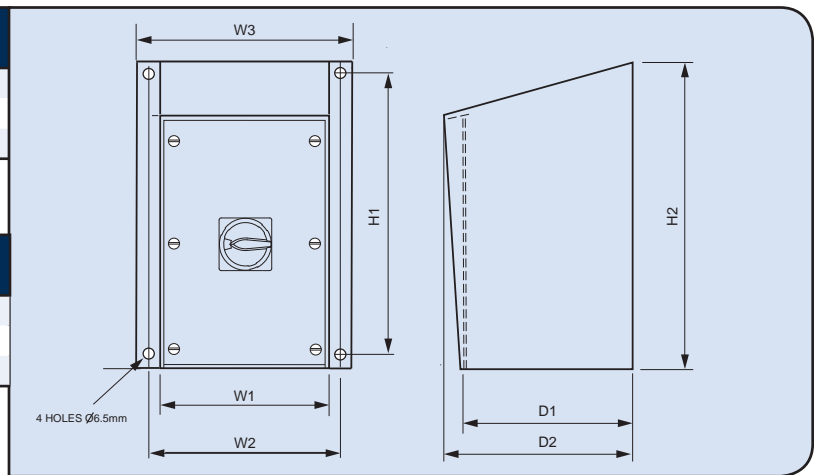

	4 Pole (3ph + Sw N <sup>1</sup> ) +2 N.O. aux		le AC-21A
KG10	T204/GBA680 *SR04L		20A
KG20	T204/GBA680 *SR04L		25A
KG32	T204/GBA680 *SR04L		32A
KG20	T204/GBA602 *SR14L		25A <sup>2</sup>
KG32	T204/GBA602 *SR14L		32A <sup>2</sup>
KG41	T204/GBA602 *SR14L		40A
KG64	T204/GBA602 *SR14L		63A
KG80	T204/GBA602 *SR24L		80A
KG100	T204/GBA602 *SR24L		100A
KG105	T204/GBA602 *SR24L		125A

**Note** 1) Switched neutral pole is early make/late break.  
2) Larger enclosure size (SR14L)

# OFF-ON / SWITCH DISCONNECTORS



## Main/Emergency-Off Switch 25A - 315A

3, 4 & 6 POLE



- IP & IK RATING** IP66 + IK10 protection
- ENCLOSURE** GRP, grey RAL7035
- HANDLE OPTION** red & yellow padlockable handle  
optional black handle available
- EARTH TERMINAL** included
- SAFETY FEATURE** switch is interlocked with the lid to prevent opening in 'ON' position

le AC-21A	3 Pole		3 Pole + Solid Neutral (TP&N)		4 Pole (3ph + Sw N <sup>2</sup> )	
25A	KG20	T203/GB00U2 *GP1	KG20	T207/GB00U2 *GP1	KG20	T204/GB00U2 *GP1
32A	KG32	T203/GB00U2 *GP1	KG32	T207/GB00U2 *GP1	KG32	T204/GB00U2 *GP1
40A	KG41	T203/GB00U2 *GP1	KG41	T207/GB00U2 *GP1	KG41	T204/GB00U2 *GP1
63A	KG64	T203/GB00U2 *GP1	KG64	T207/GB00U2 *GP1	KG64	T204/GB00U2 *GP1
80A	KG80	T203/GB00U2 *GP1	KG80	T207/GB00U2 *GP1	KG80	T204/GB00U2 *GP1
100A	KG100	T203/GB00U2 *GP1	KG100	T207/GB00U2 *GP1	KG100	T204/GB00U2 *GP1
125A	KG105	T203/GB00U2 *GP1	KG105	T207/GB00U2 *GP1	KG105	T204/GB00U2 *GP1
125A <sup>3)</sup>	KG125	T203/GB00T2 *GP6	KG125	T207/GB00T2 *GP6	KG125	T204/GB00T2 *GP6
160A	KG160	T203/GB00T2 *GP6	KG160	T207/GB00T2 *GP6	KG160	T204/GB00T2 *GP6
200A	KG210	T203/GB00T1 *GP6	KG210	T207/GB00T1 *GP6	KG210	T204/GB00T1 *GP6
250A	KG250	T203/GB00T1 *GP6	KG250	T207/GB00T1 *GP6	KG250	T204/GB00T1 *GP6
315A	KG315	T203/GB00T1 *GP6	KG315	T207/GB00T1 *GP6	KG315	T204/GB00T1 *GP6

le AC-21A	3 Pole		3 Pole + Solid Neutral (TP&N)		4 Pole (3ph + Sw N <sup>2</sup> )	
25A	KG20	T203/GB20U2 *GP1	KG20	T207/GB20U2 *GP1	KG20	T204/GB20U2 *GP1
32A	KG32	T203/GB20U2 *GP1	KG32	T207/GB20U2 *GP1	KG32	T204/GB20U2 *GP1
40A	KG41	T203/GB20U2 *GP1	KG41	T207/GB20U2 *GP1	KG41	T204/GB20U2 *GP1
63A	KG64	T203/GB20U2 *GP1	KG64	T207/GB20U2 *GP1	KG64	T204/GB20U2 *GP1
80A	KG80	T203/GB20U2 *GP1	KG80	T207/GB20U2 *GP1	KG80	T204/GB20U2 *GP1
100A	KG100	T203/GB20U2 *GP1	KG100	T207/GB20U2 *GP1	KG100	T204/GB20U2 *GP1
125A	KG105	T203/GB20U2 *GP1	KG105	T207/GB20U2 *GP1	KG105	T204/GB20U2 *GP1
125A <sup>3)</sup>	KG125	T203/GB22T2 *GP6	KG125	T207/GB22T2 *GP6	KG125	T204/GB22T2 *GP6
160A	KG160	T203/GB22T2 *GP6	KG160	T207/GB22T2 *GP6	KG160	T204/GB22T2 *GP6
200A	KG210	T203/GB22T1 *GP6	KG210	T207/GB22T1 *GP6	KG210	T204/GB22T1 *GP6
250A	KG250	T203/GB22T1 *GP6	KG250	T207/GB22T1 *GP6	KG250	T204/GB22T1 *GP6
315A	KG315	T203/GB22T1 *GP6	KG315	T207/GB22T1 *GP6	KG315	T204/GB22T1 *GP6

## Main/Emergency-Off Switch Flush Mounting 20A - 63A 2, 3 & 4 POLE



- IP RATING** IP40 protection (IP65 achievable using suitable sealant)
- MOUNTING PLATE** stainless steel, grade 316L
- HANDLE OPTION** red and yellow padlockable handle  
optional black handle available
- FEATURE** galvanised steel adaptable box included, with M20 conduit knock outs and earth stud

le AC-21A	Order Code No.	
<b>2 pole</b>		
20A	KG10	T202/GBA011*SF1
<b>3 pole</b>		
20A	KG10	T203/GBA286*SF1
25A	KG20	T203/GBA286*SF2
32A	KG32	T203/GBA286*SF2
40A	KG41	T203/GBA286*SF3
63A	KG64	T203/GBA286*SF3
<b>4 pole</b>		
20A	KG10	T204/GBA304*SF1
25A	KG20	T204/GBA304*SF2
32A	KG32	T204/GBA304*SF2
40A	KG41	T204/GBA304*SF3
63A	KG64	T204/GBA304*SF3

# GRP enclosure



Encl. Ref.	A	B	C	D	E	F	G
GP1	300	265	165	222	316	354	184
GP3	425	325	180	348	377	480	245
GP6	500	430	210	423	485	555	353
GP23	650	540	260	573	594	705	462
GP27	805	615	315	723	665	855	533

Please refer to end of part no. for enclosure reference.  
See tables below:

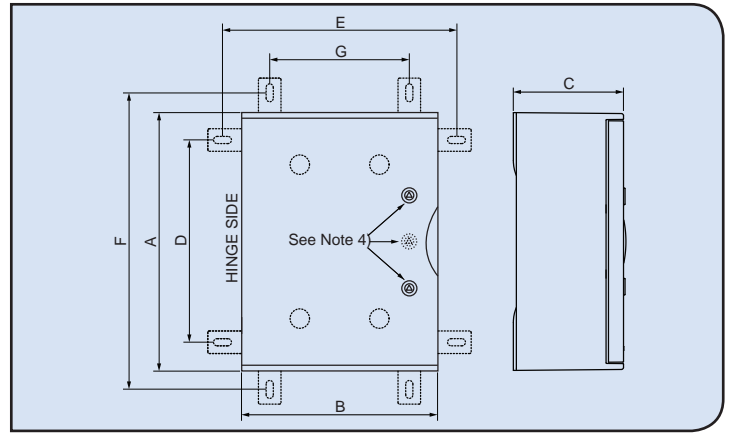

6 Pole		le AC-21A
KG20B	T206/GB00U2 *GP1	25A
KG32B	T206/GB00U2 *GP1	32A
KG41B	T206/GB00U2 *GP1	40A
KG64B	T206/GB00U2 *GP1	63A
KG80	T206/GB00U2 *GP3	80A
KG100	T206/GB00U2 *GP3	100A
KG105	T206/GB00U2 *GP3	125A
KG125	T206/GB00T2 *GP6	125A <sup>3)</sup>
KG160	T206/GB00T2 *GP6	160A
C200-4	T206/GB00T1 *GP23	200A
		250A
C316	T206/GB00T1 *GP27	315A

## Options can include:

- terminal blocks
- lid mounted push buttons & pilot lights
- emergency stop push button
- lockable door

External mounting brackets (which can be fitted either vertically or horizontally) are included as standard.

6 Pole		le AC-21A
KG20B	T206/GB20U2 *GP1	25A
KG32B	T206/GB20U2 *GP1	32A
KG41B	T206/GB20U2 *GP1	40A
KG64B	T206/GB20U2 *GP1	63A
KG80	T206/GB20U2 *GP3	80A
KG100	T206/GB20U2 *GP3	100A
KG105	T206/GB20U2 *GP3	125A
KG125	T206/GB22T2 *GP6	125A <sup>3)</sup>
KG160	T206/GB22T2 *GP6	160A
C200-4	T206/GB22T1 *GP23	200A
		250A
C316	T206/GB22T1 *GP27	315A

### Notes

- The following auxiliary contacts are provided:-  
 KG20 to KG105            2 N.O. (early break)  
 KG125 to KG315        2 N.O. (early break) + 2 N.C.  
 C200-4 & C316            2 N.O. (early break)
- Switched neutral pole is early make/late break.
- KG125 suitable for applications requiring larger cable termination and increased enclosure size.
- GP1 enclosures have only 1 quarter turn lock, GP3, GP6, GP23 & GP27 enclosures have 2 quarter turn locks.

# stainless steel plate + galvanised steel adaptable box



Encl. Ref.	Front Plate			Adaptable Box			Cable Entries.
	H	W	T	H1	W1	D	
SF1	100	100	2	78	78	77	8 x 20mm k'outs
SF2	125	125	2	103	103	77	12 x 20mm k'outs
SF3	175	175	2	153	153	102	16 x 20mm k'outs

Please refer to end of part no. for enclosure reference.  
See adjacent table.

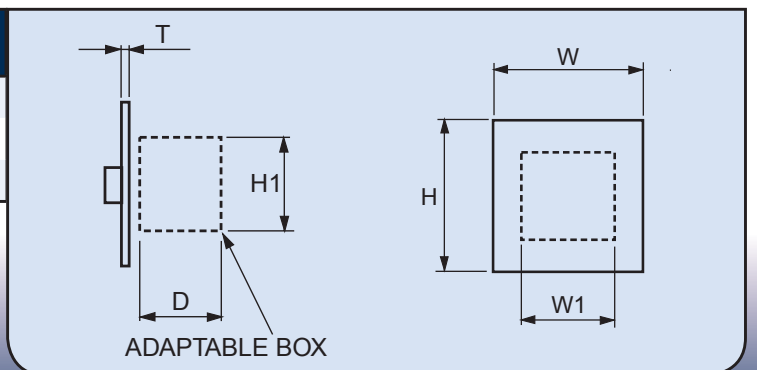

# OFF-ON / SWITCH DISCONNECTORS



**Defeatable door interlock**

**25A - 125A**

**3, 3 + Neutral & 4 POLE**



- IP & IK RATING** IP66 + IK10 protection
- ENCLOSURE** GRP, grey (RAL7035)
- HANDLE OPTION** red/yellow padlockable handle  
optional black handle available
- EARTH TERMINAL** included
- SAFETY FEATURE** when required for maintenance purposes, qualified personnel can defeat the door interlock and enable the door to be opened whilst the switch is in the "ON" position

KG41 - KG105, 3 & 4 pole items above utilise the M800 defeatable door interlock device. (See note 6)

KG125 - KG160, 3 & 4 pole + KG41B - KG160, 6 pole items above utilise the M700 defeatable door interlock device. (See note 6)

le AC-21A	3 Pole + Aux		4 Pole (3ph + Sw N <sup>2</sup> ) + aux <sup>1</sup>	
40A	KG41	T203/GB20V3 *GP1	KG41	T204/GB20V3 *GP1
63A	KG64	T203/GB20V3 *GP1	KG64	T204/GB20V3 *GP1
80A	KG80	T203/GB20V3 *GP1	KG80	T204/GB20V3 *GP1
100A	KG100	T203/GB20V3 *GP1	KG100	T204/GB20V3 *GP1
125A	KG105	T203/GB20V3 *GP1	KG105	T204/GB20V3 *GP1
125A <sup>3)</sup>	KG125	T203/GB22V5 *GP18	KG125	T204/GB22V5 *GP18
160A	KG160	T203/GB22V5 *GP18	KG160	T204/GB22V5 *GP18
200A	KG210	T203/GB22V5 *GP18	KG210	T204/GB22V5 *GP18
250A	KG250	T203/GB22V5 *GP18	KG250	T204/GB22V5 *GP18
315A	KG315	T203/GB22V5 *GP18	KG315	T204/GB22V5 *GP18

## Main/Emergency-Off Switch

**20A - 315A**

**3 & 6 POLE**

- IP RATING** IP66/67 protection
- ENCLOSURE** grey insulated enclosure
- HANDLE OPTION** red and yellow padlockable handle optional black handle available

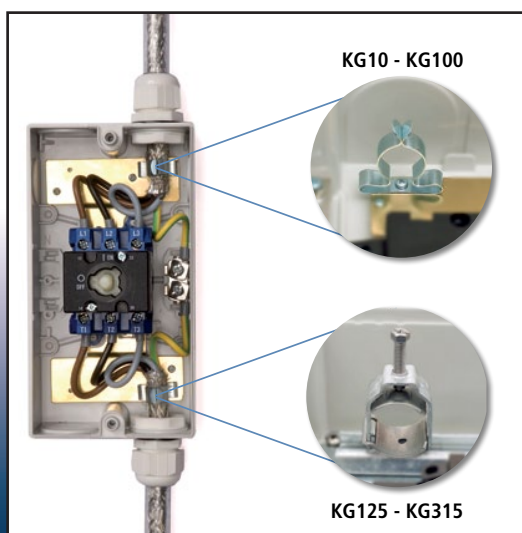

Screened Cable Dimensions (mm)	
KG10	9 - 11
KG20, KG32, KG20B, KG32B	12 - 16
KG41, KG64	12 - 16
KG41B, KG64B	23 - 29
KG80, KG100	23 - 29
KG80C, KG100C	28 - 34
KG125 - KG250	34 - 40
KG315	46 - 52





Encl. Ref.	A	B	C	D	E	F	G	H	I
GP1	300	265	165	110	150	222	316	354	184
GP17	425	325	180	132	255	348	377	480	245
GP18	500	430	210	240	330	423	485	555	353

Please refer to end of part no. for enclosure reference. See table below:

## Options can include:

- terminal blocks
- lid mounted push buttons & pilot lights
- emergency stop push button
- lockable door

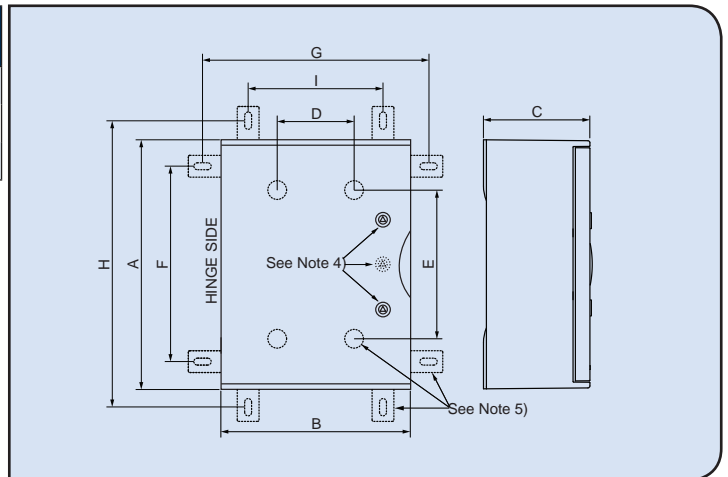

	6 Pole + aux <sup>1</sup>		le AC-21A
KG41B	T206/GB20V5 *GP17		40A
KG64B	T206/GB20V5 *GP17		63A
KG80	T206/GB20V5 *GP17		80A
KG100	T206/GB20V5 *GP17		100A
KG105	T206/GB20V5 *GP17		125A
KG125	T206/GB22V5 *GP18		125A <sup>3)</sup>
KG160	T206/GB22V5 *GP18		160A
			200A
			250A
			315A

### Notes

- 1) The following auxiliary contacts are provided:-  
 KG41 to KG105      2 N.O. (early break)  
 KG125 to KG160    2 N.O. (early break) + 2 N.C.
- 2) Switched neutral pole is early make/late break.
- 3) KG125 suitable for applications requiring larger cable termination and increased enclosure size.
- 4) GP1 enclosures have 1 quarter turn lock, GP17 & GP18 enclosures have 2 quarter turn locks.
- 5) Dimensions 'D' and 'E' show the position for drilling internal fixing holes. External mounting brackets (which can be fixed either horizontally or vertically), are included with each switch.
- 6) In normal operation the switch handle is padlockable in the OFF position only and interlocked with the shaft in the ON position to prevent opening of the panel door. Shaft and handle are also interlocked in the OFF position if a padlock is fitted to the handle with the panel door closed.

## EMC compliant connection insulated enclosure



**FEATURES** integral metal plate to maintain cable screen continuity between input and output cables. Screen termination by spring clamp (KG10-KG100) or screw clamp (KG125 - KG315). Connections for screened control cables also available interlocked lid

le AC-21A	3 Pole + 1 n/o + 1n/c aux	Encl. Ref		6 Pole + 1 n/o + 1n/c aux		
20A	KG10 T203/D-A076 KS51V	KS51V				
25A	KG20 T203/D-A159 KL51V	KL51V		KG20B T206/D-A059 KL11V	KL11V	
32A	KG32 T203/D-A117 KL51V	KL51V		KG32B T206/D-A054 KL11V	KL11V	
40A	KG41 T203/D-A145 KL11V	KL11V		KG41B T206/D-A052 KL11V	KL71V	
63A	KG64 T203/D-A173 KL11V	KL11V		KG64B T206/D-A066 KL11V	KL71V	
80A	KG80 T203/D-A108 KL71V	KL71V		KG80C T206/D-A070 KL11V	STM	
100A	KG100 T203/D-A120 KL71V	KL71V		KG100C T206/D-A060 KL11V	STM	
125A	KG125 T203/D-A082 STM	STM		KG125 T206/D-A020 KL11V	STM	
160A	KG160 T203/D-A077 STM	STM		KG160 T206/D-A040 KL11V	STM	
250A	KG250 T203/D-A075 STM	STM				
315A	KG315 T203/D-A034 STM	STM				

Main/Emergency-Off Switch

25A - 315A

3, 4 & 6 POLE



IP& IK RATING	IP66 + IK10 protection
ENCLOSURE	GRP, grey (RAL7035) or red (RAL3000)
HANDLE OPTION	red & yellow padlockable handle optional black handle available
EARTH TERMINAL	included
FEATURE	key lockable hinged lid, with interlock to prevent opening in the "ON" position

Combine a number of different switches & devices in one enclosure.

Kraus & Naimer offer a standard range of rotary isolators and changeover switches in GRP enclosures ranging from 25A to 315A, from 3 - 6 Pole and can also offer a variety of different fitted options from stock.

## ALL-in-ONE solution

Combine a number of different switches/devices in one enclosure.

- Faster & safer installation
- Maximum flexibility
- Cost effective

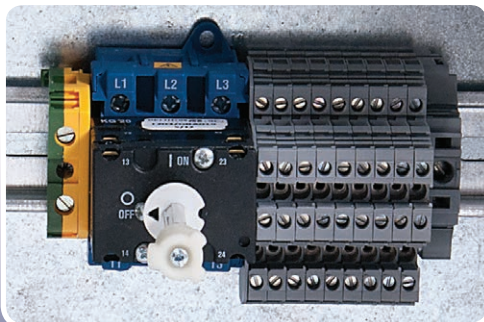

Please contact us to discuss your exact requirements. Our team are highly trained and ready to help with any technical questions you may have.



Options include:



# OFF-ON / SWITCH DISCONNECTORS insulated, mild & stainless steel enclosure

## Main/Emergency-Off Switch + Emergency Stop Pushbutton

25A - 100A 4 & 6 POLE



- IP RATING **IP66/67 protection**
- ENCLOSURE **insulated, grey (RAL7035)**
- HANDLE OPTION **red/yellow padlockable handle**
- EARTH TERMINAL **included**
- FEATURES **stayput emergency-stop pushbutton, 1 N.C. contact, twist to reset. Switch interlocked with lid to prevent opening in 'ON' position**

le AC-21A	Order Code No.		Encl.Ref.
<b>4 pole (3 ph+Sw N<sup>1</sup>) + 1 n.o. (early break) + 1 n.c. aux</b>			
25A	KG20	T204/GBA285*KL	KLD
32A	KG32	T204/GBA285*KL	KLD
40A	KG41	T204/GBA285*KL	KLD
63A	KG64	T204/GBA285*KL	KLD
80A	KG80	T204/GBA285*KL	KLD
100A	KG100	T204/GBA285*KL	KLD
<b>6 pole + 1 n.o. (early break) + 1 n.c. aux</b>			
25A	KG20B	T206/GBA095*KL	KLD
32A	KG32B	T206/GBA095*KL	KLD
40A	KG41B	T206/GBA095*KL	KLD
63A	KG64B	T206/GBA095*KL	KLD

## Main/Emergency-Off Switch + Emergency Stop Pushbutton

25A - 100A 4 & 6 POLE



- IP RATING **IP66 protection**
- ENCLOSURE **grey powder paint finish (RAL7032) also available in red paint finish (RAL3000)**
- HANDLE OPTION **red/yellow padlockable handle**
- EARTH TERMINAL **included + lid bonding link**
- FEATURES **stayput emergency stop pushbutton, 1 N.C. contact, twist to reset. Switch interlocked with the lid to prevent opening in 'ON' position**

le AC-21A	Order Code No.		Encl.Ref.
<b>4 pole (3 ph+Sw N<sup>1</sup>) + 1 n.o. (early break) + 1 n.c. aux</b>			
25A	KG20	T204/GBA350* MB3E	MB3E
32A	KG32	T204/GBA350* MB3E	MB3E
40A	KG41	T204/GBA350* MB3E	MB3E
63A	KG64	T204/GBA350* MB3E	MB3E
80A	KG80	T204/GBA350* MB3E	MB3E
100A	KG100	T204/GBA350* MB3E	MB3E
<b>6 pole + 1 n.o. (early break) + 1 n.c. aux</b>			
25A	KG20B	T206/GBA155*MB3E	MB3E
32A	KG32B	T206/GBA155*MB3E	MB3E
40A	KG41B	T206/GBA155*MB3E	MB3E
63A	KG64B	T206/GBA155*MB3E	MB3E

## Main/Emergency-Off Switch + Emergency Stop Pushbutton

25A - 100A 4 & 6 POLE



- IP RATING **IP66 protection**
- ENCLOSURE **stainless steel, grade 316L**
- HANDLE OPTION **red/yellow padlockable handle**
- EARTH TERMINAL **included + lid bonding link**
- FEATURES **stayput emergency stop pushbutton, 1 N.C. contact, twist to reset. Switch interlocked with the lid to prevent opening in 'ON' position**

le AC-21A	Order Code No.		Encl.Ref.
<b>4 pole (3 ph+Sw N<sup>1</sup>) + 1 n.o. (early break) + 1 n.c. aux</b>			
25A	KG20	T204/GBA440* SB3E	SB3E
32A	KG32	T204/GBA440* SB3E	SB3E
40A	KG41	T204/GBA440* SB3E	SB3E
63A	KG64	T204/GBA440* SB3E	SB3E
80A	KG80	T204/GBA440* SB3E	SB3E
100A	KG100	T204/GBA440* SB3E	SB3E
<b>6 pole + 1 n.o. (early break) + 1 n.c. aux</b>			
25A	KG20B	T206/GBA555*SB3E	SB3E
32A	KG32B	T206/GBA555*SB3E	SB3E
40A	KG41B	T206/GBA555*SB3E	SB3E
63A	KG64B	T206/GBA555*SB3E	SB3E

Encl. Ref.	H	Encl. Dim.			Encl. Dim.			Cable Entries.	Line Drg.
		W	D	D1	H1	W1	d		
KLD	250	145	107	-	229	124	6.5	4 x 25/40mm k'outs	Fig. 2
MB3E	254	149	125	8	193	167	6	-	Fig. 4
SB3E	254	149	126.5	-	193	167	6	-	Fig. 5

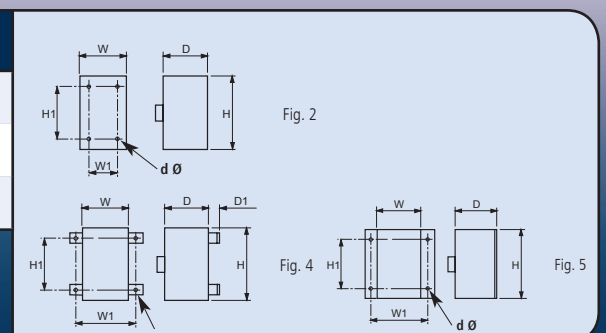

Notes 1) Switched neutral pole is early make / late break

# CHANGEOVER / SWITCH DISCONNECTORS

## Changeover Switch with centre off

16A - 160A

2, 3 & 4 POLE

Insulated



- IP66/67 protection
- auxiliary contacts provided with 3 & 4 pole switches
- black & red handle, padlockable in 'OFF' position
- earth terminal
- grey insulated enclosed (RAL7035)
- switch interlocked with lid to prevent opening in 'ON' position

le AC-21A	2 Pole		Encl. Ref.		
16A	KH16	T902/GBA002 *KS52	KSA		
20A	KH20	T902/GBA002 *KS52	KSA		
25A	KH25	T902/GBA002 *KS52	KSA		
32A	KH32	T902/GBA002 *KL12	KLC		
40A	KH40	T902/GBA002 *KL12	KLC		
63A	KH63	T902/GBA002 *KL72	KLE		
80A	KH80	T902/GBA002 *KL72	KLE		
100A	KH85	T902/GBA012 *KL72	KLE		
125A					
125A <sup>3)</sup>					
160A					

Mild Steel



- IP66 protection
- auxiliary contacts provided with 3 & 4 pole switches
- black & red handle, padlockable in 'OFF' position
- earth terminal & lid bonding link included
- grey powder paint finish (RAL7032) also available in red powder paint finish (RAL3000)
- switch interlocked with lid to prevent opening in 'ON' position

le AC-21A	2 Pole		Encl. Ref.		
16A	KH16	T902/GBA020 *MB2	MB2		
20A	KH20	T902/GBA020 *MB2	MB2		
25A	KH25	T902/GBA020 *MB2	MB2		
32A	KH32	T902/GBA020 *MB2	MB2		
40A	KH40	T902/GBA020 *MB2	MB2		
63A	KH63	T902/GBA020 *MB3	MB3		
80A	KH80	T902/GBA020 *MB3	MB3		
100A	KH85	T902/GBA020 *MB3	MB3		
125A					
125A <sup>3)</sup>					
160A					

Stainless Steel



- IP66 protection
- auxiliary contacts provided with 3 & 4 pole switches
- black & red handle, padlockable in 'OFF' position
- earth terminal & lid bonding link included
- stainless steel enclosure, grade 316L
- switch interlocked with lid to prevent opening in 'ON' positions

le AC-21A	2 Pole		Encl. Ref.		
16A	KH16	T902/GBA025 *SB2	SB2		
20A	KH20	T902/GBA025 *SB2	SB2		
25A	KH25	T902/GBA025 *SB2	SB2		
32A	KH32	T902/GBA025 *SB2	SB2		
40A	KH40	T902/GBA025 *SB2	SB2		
63A	KH63	T902/GBA025 *SB3	SB3		
80A	KH80	T902/GBA025 *SB3	SB3		
100A	KH85	T902/GBA025 *SB3	SB3		
125A					
125A <sup>3)</sup>					
160A					

### Notes

- 1) 2-off electrically isolated early break auxiliary contacts are provided with the 3 & 4 pole switches. One of these contacts closes in position 1 and the other contact closes in position 2. Both of the contacts are open in the Off position.
- 2) Switched neutral pole is early make/late break.
- 3) KG125 suitable for applications requiring larger cable termination and increased enclosure size.



# insulated, mild & stainless steel enclosure



3 Pole <sup>1)</sup>		Encl. Ref.	4 Pole (3ph+Sw N <sup>2)</sup> <sup>1)</sup>		Encl. Ref.
KG20B	T903/GBA013 *KL	KLC	KG20B	T904/GBA014 *KL	KLD
KG32B	T903/GBA013 *KL	KLC	KG32B	T904/GBA014 *KL	KLD
KG41B	T903/GBA013 *KL	KLD	KG41B	T904/GBA004 *ST	ST2
KG64B	T903/GBA013 *KL	KLD	KG64B	T904/GBA004 *ST	ST2
KG80	T903/GBA013 *ST	STE	KG80	T904/GBA004 *ST	ST3
KG100	T903/GBA013 *ST	STE	KG100	T904/GBA004 *ST	ST3
KG105	T903/GBA013 *ST	STE	KG105	T904/GBA004 *ST	ST3
KG125	T903/GBA035 *ST	ST4	KG125	T904/GBA045 *ST	ST4
KG160	T903/GBA035 *ST	ST4	KG160	T904/GBA045 *ST	ST4

3 Pole <sup>1)</sup>		Encl. Ref.	4 Pole (3ph+Sw N <sup>2)</sup> <sup>1)</sup>		Encl. Ref.
KG20B	T903/GBA030 *MB3	MB3	KG20B	T904/GBA040 *MB3	MB3
KG32B	T903/GBA030 *MB3	MB3	KG32B	T904/GBA040 *MB3	MB3
KG41B	T903/GBA030 *MB3	MB3	KG41B	T904/GBA040 *MB3	MB3
KG64B	T903/GBA030 *MB3	MB3	KG64B	T904/GBA040 *MB3	MB3
KG80	T903/GBA030 *MB4	MB4	KG80	T904/GBA040 *MB4	MB4
KG100	T903/GBA030 *MB4	MB4	KG100	T904/GBA040 *MB4	MB4
KG105	T903/GBA030 *MB4	MB4	KG105	T904/GBA040 *MB4	MB4
KG125	T903/GBA055 *MB9	MB9	KG125	T904/GBA065 *MB9	MB9
KG160	T903/GBA055 *MB9	MB9	KG160	T904/GBA065 *MB9	MB9

3 Pole <sup>1)</sup>		Encl. Ref.	4 Pole (3ph+Sw N <sup>2)</sup> <sup>1)</sup>		Encl. Ref.
KG20B	T903/GBA050 *SB3	SB3	KG20B	T904/GBA060 *SB3	SB3
KG32B	T903/GBA050 *SB3	SB3	KG32B	T904/GBA060 *SB3	SB3
KG41B	T903/GBA050 *SB3	SB3	KG41B	T904/GBA060 *SB3	SB3
KG64B	T903/GBA050 *SB3	SB3	KG64B	T904/GBA060 *SB3	SB3
KG80	T903/GBA050 *SB4	SB4	KG80	T904/GBA060 *SB4	SB4
KG100	T903/GBA050 *SB4	SB4	KG100	T904/GBA060 *SB4	SB4
KG105	T903/GBA050 *SB4	SB4	KG105	T904/GBA060 *SB4	SB4
KG125	T903/GBA075 *SB9	SB9	KG125	T904/GBA085 *SB9	SB9
KG160	T903/GBA075 *SB9	SB9	KG160	T904/GBA085 *SB9	SB9

Encl. Ref.	Encl. Dim.				Encl. Dim.		
	H	W	D	D1	H1	W1	d
KSA	120	85	80	-	110	-	4.2
KLC	190	100	91	-	178	-	5.6
KLD	250	145	107	-	229	124	6.5
KLE	250	145	107	-	229	124	6.5
STE	280	190	230	-	254	164	7
ST2	280	190	130	-	254	164	7
ST3	380	280	180	-	354	254	7
ST4	560	380	180	-	534	354	7
MB2	194	119	115	-	133	137	6
MB3	254	149	125	8	193	167	6
MB4	309	234	150	8	248	252	6
MB9	500	400	175	-	440	340	6.5
SB2	194	119	116.5	-	133	137	6
SB3	254	149	126.5	-	193	167	6
SB4	309	234	151.5	-	248	252	6
SB9	500	400	175	-	440	340	6.5

Encl. Ref.	Cable Entries.	Line Drg.
KSA	4 x 20/25mm k'outs	Fig. 1
KLC	4 x 20/25mm k'outs	Fig. 1
KLD	4 x 25/40mm k'outs	Fig. 2
KLE	4 x 25/40mm k'outs	Fig. 2
STE	1 x gland plate	Fig. 2
ST2	2 x gland plates	Fig. 2
ST3	2 x gland plates	Fig. 2
ST4	2 x gland plates	Fig. 2
MB2	-	Fig. 4
MB3	-	Fig. 4
MB4	-	Fig. 4
MB9	2 x gland plates	Fig. 6
SB2	-	Fig. 5
SB3	-	Fig. 5
SB4	-	Fig. 5
SB9	2 x gland plates	Fig. 6

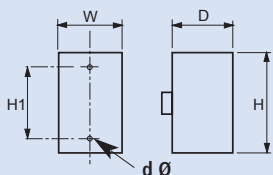

Fig. 1

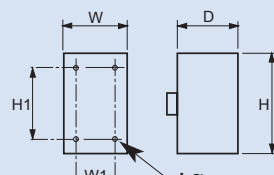

Fig. 2

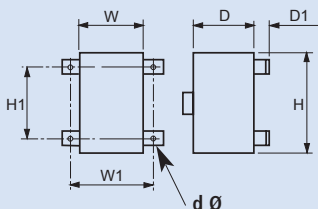

Fig. 4

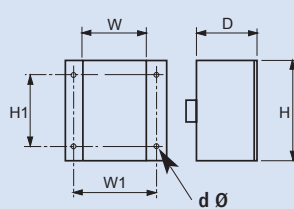

Fig. 5

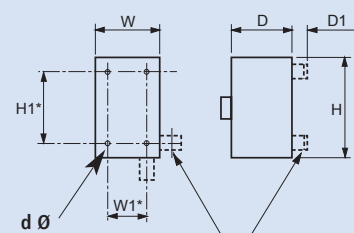

Fig. 6

EXTERNAL MTG. BKTS - FITTED THEY ADD 120mm TO EITHER W1 OR H1 DIMENSION & dØ - 8.5DIA

# CHANGEOVER / SWITCH DISCONNECTORS

**Changeover Switch with centre off 16A - 315A 2, 3 & 4 POLE**



- IP & IK RATING** IP66 + IK10 protection
- ENCLOSURE** GRP, grey (RAL7035)
- HANDLE OPTION** black & red padlockable handle
- EARTH TERMINAL** included
- SAFETY FEATURE** switch is interlocked with the lid to prevent opening in 'ON' position

le AC-21A	2 Pole		3 Pole + aux <sup>1</sup>			
16A	KH16	T902/GBC0T1 *GP2				
20A	KH20	T902/GBC0T1 *GP2				
25A	KH25	T902/GBC0T1 *GP2	KG20B	T903/GBC1U1 *GP1		
32A	KH32	T902/GBC0T1 *GP2	KG32B	T903/GBC1U1 *GP1		
40A	KH40	T902/GBC0T1 *GP2	KG41B	T903/GBC1U1 *GP1		
63A	KH63	T902/GBC0T1 *GP2	KG64B	T903/GBC1U1 *GP1		
80A	KH80	T902/GBC0T1 *GP2	KG80	T903/GBC1U1 *GP3		
100A	KH85	T902/GBC0T1 *GP2	KG100	T903/GBC1U1 *GP3		
125A			KG105	T903/GBC1U1 *GP3		
125A <sup>3)</sup>			KG125	T903/GBC1T1 *GP6		
160A			KG160	T903/GBC1T1 *GP6		
200A			C200-4	T903/GBC1T1 *GP23		
315A			C316	T903/GBC1T1 *GP27		

If padlocking in "ALL POSITIONS" is required then change the 6th character of the GBC references to "6" For example:

Part no - KH16 T902/GBC0T1 \*GP2 becomes KH16 T902/GBC0T6 \*GP2 pricing remains the same.

## LOAD SWITCH - Changeover Switch with Centre Off 32A - 315A 4 POLE

- IP RATING** IP66 protection
- ENCLOSURE** grey insulated enclosure
- HANDLE OPTION** black and red padlockable handle available



le AC-21A	Order Code No.		Encl. Ref.	
<b>4 Pole</b>				
32A	CA25	A213/GBA009 *MB20	MB20	
40A	C32	A213/GBA009 *MB20	MB20	
63A	C42	A213/GBA009 *MB20	MB20	
100A	C80	A213/GBA009 *MB22	MB22	
150A	C125	A213/GBA009 *MB22	MB22	
200A	C200-4	A213/GBA002 *MB10	MB10	
275A	C315	A213/GBA002 *MB10	MB10	
315A	C315	A213/GBA010 *MB29	MB29	

# GRP & painted mild steel enclosure



Encl. Ref.	A	B	C	D	E	F	G	H	I
GP1/GP2	303	265	167	110	150	222	316	354	184
GP3	428	325	183	132	255	348	377	480	245
GP6	500	430	210	240	330	423	485	555	353
GP23	654	543	265	348	480	573	594	705	462
GP27	806	616	319	420	630	723	665	855	533

Please refer to end of part no. for enclosure

## Options can include:

- terminal blocks
- lid mounted push buttons & pilot lights
- emergency stop push button
- key lockable door

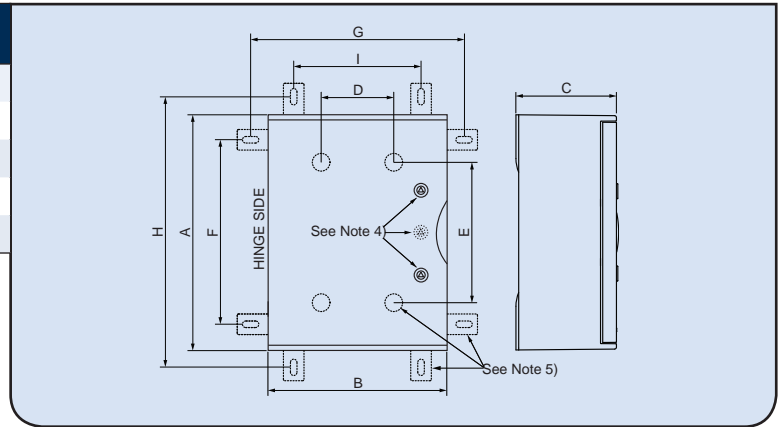

	4 Pole (3ph + Sw N <sup>2</sup> ) + aux <sup>1</sup>		1e AC-21A
			16A
			20A
KG20B	T904/GBC1U1 *GP1		25A
KG32B	T904/GBC1U1 *GP1		32A
KG41B	T904/GBC1U1 *GP1		40A
KG64B	T904/GBC1U1 *GP1		63A
KG80	T904/GBC1U1 *GP3		80A
KG100	T904/GBC1U1 *GP3		100A
KG105	T904/GBC1U1 *GP3		125A
KG125	T904/GBC1T1 *GP6		125A <sup>3)</sup>
KG160	T904/GBC1T1 *GP6		160A
C200-4	T904/GBC1T1 *GP23		200A
C316	T904/GBC1T1 *GP27		315A

### Notes

- 1) 2-off electrically isolated early break auxiliary contacts are provided. One of these contacts closes in position 1 and the other contact closes in position 2. Both of the contacts are open in the OFF position.
- 2) Switched neutral pole is early make/late break.
- 3) KG125 suitable for applications requiring larger cable termination and increased enclosure size.
- 4) GP1/GP2 enclosures have 1 quarter turn lock, GP3, GP6, GP23 & GP27 enclosures have 2 quarter turn locks.
- 5) Dimensions 'D' and 'E' show the position for drilling internal fixing holes. External mounting brackets, which can be fixed either horizontally or vertically, are included with each switch.



**EARTH TERMINAL** included + lid bonding link

**SAFETY FEATURE** switch is interlocked with the lid to prevent opening in 'ON' position

Encl. Ref.	Encl. Dim.				Encl. Dim.		
	H	W	D	D1	H1	W1	d
MB10	500	400	300	-	440	340	6.5
MB20	250	175	175	-	225	195	6
MB22	400	300	275	-	340	240	6.5
MB29	750	450	300	-	690	390	6.5
Encl. Ref.	Cable Entries.						Line Drg.
MB10	2 x gland plates						Fig. 6
MB20	-						Fig. 4
MB22	2 x gland plates						Fig. 6
MB29	2 x gland plates						Fig. 6

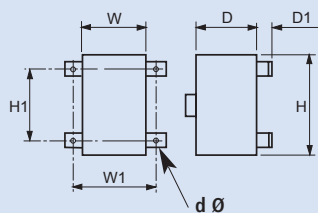

Fig. 4

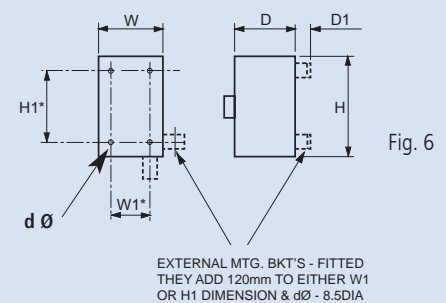

Fig. 6

# PV SWITCH DISCONNECTORS



## AC Switch Disconnectors - Single & Three Phase AC-21A 25 - 40A



- IP RATING **IP66/67 protection**
- ENCLOSURE **grey insulated (RAL7035)**
- HANDLE OPTION **red/yellow padlockable**
- EARTH TERMINAL **included**
- FEATURE **switch interlocked with lid to prevent opening in 'ON' position**

### AC Switch Disconnectors - for Single Phase

Single Phase	Current Rating AC-21A (per contact)	Order Code No.	FIG.
	25A	KG20 T203/GBA270*KS1V	FIG 4
	25A	KG20 T203/GBA294*KL <sup>1)</sup>	FIG 1
	32A	KG32 T203/GBA294*KL <sup>1)</sup>	FIG 1
	40A	KG41 T203/GBA270*KL1V	FIG 2

### AC Switch Disconnectors - for Three Phase (3ph + Sw N<sup>2)</sup>)

Three Phase	Current Rating AC-21A (per contact)	Order Code No.	FIG.
	25A	KG20 T204/GBA290*KS1V	FIG 4
	25A	KG20 T204/GBA486 KL51V <sup>1)</sup>	FIG 1
	32A	KG32 T204/GBA486 KL51V <sup>1)</sup>	FIG 1
	40A	KG41 T204/GBA290*KL1V	FIG 2

<sup>1)</sup> Larger enclosure to match KG20/32 T104 DC enclosure

<sup>2)</sup> Switched neutral pole is early make / late break.

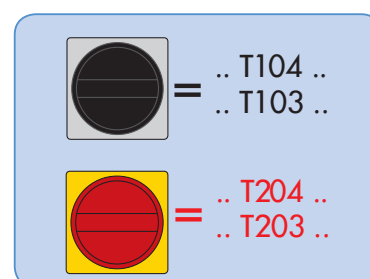
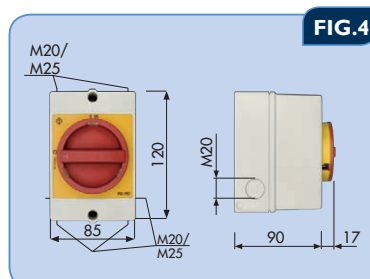
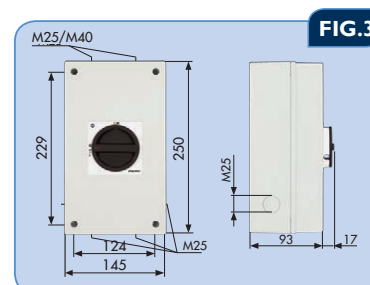
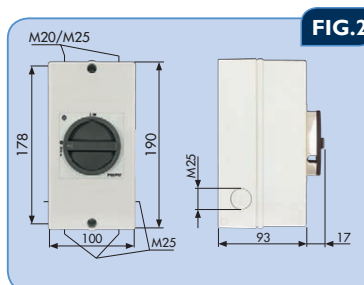
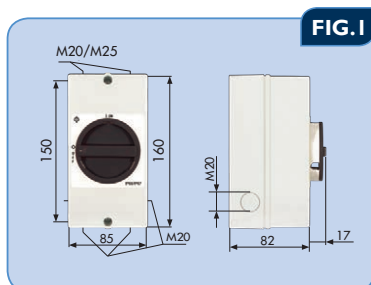



## 8 - 50A Single & Two String DC-21B - DC Switch Disconnectors

IP RATING **IP66/67 protection**

ENCLOSURE **grey insulated (RAL7035)**

HANDLE OPTION **black/grey padlockable handle**

FEATURES **switch is interlocked with the lid to prevent opening in 'ON' position**

**class II compliant**  
**rated for use in ambient temperatures up to 50°C**

**non-polarity sensitive**

**KGD40 - up to 50 amps @1000 VDC to give higher rating achieved by use of permanent magnets in the contact body used to reduce arcing time**



### Single String DC Switch Disconnectors - Selection Chart DC-21B

Single String	Voltage													Order Code No.	FIG.
	250V	375V	400V	450V	500V	600V	650V	660V	750V	800V	850V	920V	1000V		
	25A	25A	25A	25A	21A	20A	20A	18A	18A	18A	11A	11A		KG20 T104/D-P003 KL51V	FIG 1
						25A	25A	23A	23A	23A	15A	15A	12A	KG32 T104/D-P003 KL51V	FIG 1
	50A	40A	40A	30A	30A									KGD40 TD102/D-P003 KL11V	FIG 2
		50A		40A	40A	40A	30A	30A	30A		20A	20A	20A	KGD40 TD103/D-P003 KL11V	FIG 2
			50A	50A	50A		40A	40A	40A	40A	30A	30A	30A	KGD40 TD104/D-P003 KL11V	FIG 2
						50A	50A	50A	50A		40A	40A	40A	KGD40B TD106/D-P003 KL11V	FIG 3
										50A	50A	50A	50A	KGD40B TD108/D-P003 KL11V	FIG 3

### Two String DC Switch Disconnectors - Selection Chart DC-21B

Two String	Ratings Per String (220V - 500V)											Order Code No.	FIG.
	220V	250V	280V	330V	340V	375V	400V	420V	440V	460V	500V		
	25A	21A	21A	20A	20A	18A	18A	11A	11A	11A		KG20 T104/GB-P103 KL51V	FIG 1
	28A	28A	28A	25A	25A	23A	23A	15A	15A	15A	12A	KG32 T104/GB-P103 KL51V	FIG 1
	50A	50A	40A	40A	40A	40A	40A	30A	30A	30A	30A	KGD40 TD104/D-P004 KL11V	FIG 2
			50A	50A	50A	50A		40A	40A	40A	40A	KGD40B TD106/D-P004 KL11V	FIG 3
						50A	50A	50A	50A	50A		KGD40B TD108/D-P004 KL11V	FIG 3
Two String	Ratings Per String (510V - 1000V)											Order Code No.	FIG.
	510V	560V	600V	660V	680V	690V	750V	800V	920V	1000V			
	20A	20A	20A	20A	12A	12A	12A	12A	8A	8A		KGD40 TD104/D-P004 KL11V	FIG 2
	25A	23A	23A		15A	15A						KG32B T106/GB-P103 KL11V	FIG 2
					20A	18A	18A	18A	11A			KG20B T108/GB-P103 KL11V	FIG 3
	40A	40A	40A	30A	30A	30A	30A	20A	20A	20A		KGD40B TD106/D-P004 KL11V	FIG 3
				40A	40A	40A	40A	40A	30A	30A		KGD40B TD108/D-P004 KL11V	FIG 3

Please select the switch disconnector according to the maximum voltage and current output of all upstream PV modules, this must include all corrective factors according to relevant standards.

# CONTROL SWITCHES



## Emergency Stop Pushbutton Station - without protective shroud

38mm diameter red mushroom head - twist to reset. 1 N.C. contact. Complies with EN 418/EN 60204-1.



<b>Order Code No.</b>	P SN-GB0001	P N261/GBA005 *SF1A	P N091/GBA023 *SB31	P N091/GBA016 *RB31	P N091/GBA017 *MB31
<b>Encl.Ref.</b>	P1Y	SF1A	SB31	RB31	MB31
<b>insulated enclosure IP67/69K</b>		<b>flush mounted stainless steel 316L IP40 (IP65 achievable with sealant) galvanised back box earth stud included</b>	<b>surface mounted stainless steel 316L IP66 earth terminal &amp; lid bonding link</b>	<b>surface mounted Red RAL3000 mild steel IP66 earth terminal &amp; lid bonding link</b>	<b>surface mounted Grey RAL7032 mild steel IP66 earth terminal &amp; lid bonding link</b>

## Emergency Stop Pushbutton Station - without protective shroud

38mm diameter red mushroom head - key operate to reset (1 included) Complies with EN 418/EN 60204-1.



<b>Order Code No.</b>	P SN-GB0003	P N261/GBA007 *SF1A	P N091/GBA024 *SB31	P N091/GBA018 *RB31	P N091/GBA019 *MB31
<b>Encl.Ref.</b>	P1Y	SF1A	SB31	RB31	MB31
<b>insulated enclosure IP66</b>		<b>flush mounted stainless steel 316L IP40 (IP65 achievable with sealant) galvanised back box earth stud included</b>	<b>surface mounted stainless steel 316L IP66 earth terminal &amp; lid bonding link</b>	<b>surface mounted Red RAL3000 mild steel IP66 earth terminal &amp; lid bonding link</b>	<b>surface mounted Grey RAL7032 mild steel IP66 earth terminal &amp; lid bonding link</b>

## FIRE ALARM ISOLATOR - Double Pole 10A. Complies with EN BS5839 Part 1:2013, marked with the symbol for on-load isolation according to BS7671:2008



Providing a secure method of safely isolating the mains power supply to CIE during maintenance periods. The double pole device provides isolation of both the live and neutral supply and can only be operated by authorised maintenance technicians via removable key.

- compliant to BS5839 Part 1:2013
- marked with the symbol for on-load isolation according to BS7671:2008
- double pole
- key switch - removable in both positions
- supplied with 2 keys

Dimensions :  
H = 80mm W = 80mm D = 55mm

1e AC-21A	2 Pole	
10A	CA4 T302/GBA001 RPB1	

# insulated & stainless steel enclosure

Emergency Stop Pushbutton Station - with protective shroud  
 38mm diameter red mushroom head - twist to reset. 1 N.C. contact. Complies with EN 418/EN 60204-1.



P SN-GB0053	P N261/GBA010 *SF1A	P N091/GBA025 *SB31	P N091/GBA020 *RB31	P N091/GBA021 *MB31	Order Code No. Encl.Ref.
P1Y	SF1A	SB31	RB31	MB31	
insulated enclosure IP66/67	flush mounted stainless steel 316L IP40 (IP65 achievable with sealant) galvanised back box earth stud included	surface mounted stainless steel 316L IP65 earth terminal & lid bonding link	surface mounted Red RAL3000 mild steel IP65 earth terminal & lid bonding link	surface mounted Grey RAL7032 mild steel IP65 earth terminal & lid bonding link	

Emergency Stop Pushbutton Station - with protective shroud  
 38mm diameter red mushroom head - key operate to reset (1 included) Complies with EN 418/EN 60204-1.



P SN-GB0054	P N261/GBA011 *SF1A	P N091/GBA026 *SB31	P N091/GBA022 *RB31	P N091/GBA023 *MB31	Order Code No. Encl.Ref.
P1Y	SF1A	SB31	RB31	MB31	
insulated enclosure IP66/67	flush mounted stainless steel 316L IP40 (IP65 achievable with sealant) galvanised back box earth stud included	surface mounted stainless steel 316L IP65 earth terminal & lid bonding link	surface mounted Red RAL3000 mild steel IP65 earth terminal & lid bonding link	surface mounted Grey RAL7032 mild steel IP65 earth terminal & lid bonding link	

## DIMENSIONS - for all Pushbutton Stations above

Encl. Ref.	Front Plate			H1 W1 D			Cable Entries.	Line Drg.
	H	W	D	H1	W1	D		
P1Y	80	72	56	66.5	58.5	4.5	1 x 20mm + 2 x 20/25mm k'outs	Fig. 1
P2Y	85	85	101	40	65	5.5	3 x 20mm k'outs	Fig. 4
SF1A	100	100	2	78	78	52	8 x 20mm k'outs	Fig. 3
SB31	100	100	60	120	70	6.5	-	Fig. 2
RB31	100	100	60	120	70	6.5	-	Fig. 2
MB31	100	100	60	120	70	6.5	-	Fig. 2

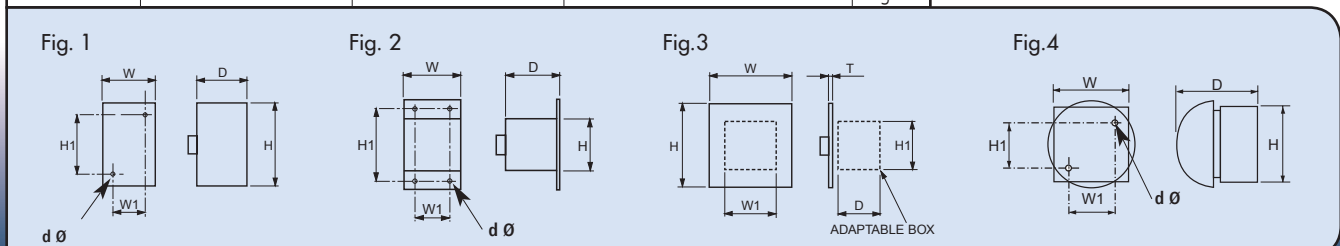





# CONTROL SWITCHES insulated enclosure

## Rotary Control Switch - Insulated Enclosure









Grey Enclosure IP65

			Order Code No.	Encl. Ref.
Off-On	1 pole		KN1	PF1A
Off-On	3 pole		KN3	PF1B
Changeover, without Off	1 pole		KN2	PF1A
Changeover, with Off	2 pole		KN10	PF1B

## Key Operated Control Switch - Insulated Enclosure



Grey Enclosure IP40

			Order Code No.	Encl. Ref.
<b>Notes</b> 1) Key removable in all positions. 2) Key removable in '0' position only.				
Off-On <sup>1)</sup>	3 pole		CA10 A202/GBA003 *PN	PN1G
Off-On <sup>1)</sup>	4 pole		CA10 A203/GBA003 *PN	PN1G
Changeover, with Off <sup>1)</sup>	2 pole		CA10 A211/GBA009 *PN	PN1G
Changeover, without Off <sup>1)</sup>	2 pole		CA10 A221/GBA003 *PN	PN1G
Changeover, spring return to Off <sup>2)</sup>	2 pole		CA10 A215/GBA002 *PN	PN1G
Step, 3 pos'n, without Off <sup>1)</sup>	1 pole		CA10 A230/GBA002 *PN	PN1G
Step, 4 pos'n, without Off <sup>1)</sup>	1 pole		CA10 A231/GBA004 *PN	PN1G

# LOAD SWITCHES

## Emergency-Off Switch - 3 & 4 Pole 25A & 32A



**IP RATING** IP65 protection  
**ENCLOSURE** grey insulated enclosure  
**HANDLE OPTION** red/yellow padlockable handle included  
**EARTH TERMINAL** included  
**FEATURE** suitable for safety isolation in accordance with IEC 60947-3/BS EN 60947-3

le AC-21A	Order Code No.	Encl. Ref.
<b>3 pole</b>		
25A	KN5	PF1E
32A	KN7	PF1E
<b>4 pole (3 ph+Sw N<sup>1)</sup>)</b>		
25A	KN6	PF1E
32A	KN8	PF1E

## Motor Reversing Switch 3 Phase 5.5kW @ 415v & 1 Phase 1.5kW @240v



**IP RATING** IP42 protection  
**ENCLOSURE** grey insulated enclosure  
**HANDLE OPTION** grey handle/silver legend  
**EARTH TERMINAL** included

Order Code No.	Encl. Ref.
KN4	PN1C

CONNECT LINK (SUPPLIED) BETWEEN TERMINALS 1 & 5

RUN WINDING      START WINDING

Encl. Ref.	Encl. Dim.			Encl. Dim.			Cable Entries.	Line Drg.
	H	W	D	H1	W1	d		
PF1A	72	64	42	36	50	4.4	4 x 20mm ISO	Fig. 2
PF1B	72	64	51	36	50	4.4	4 x 20mm ISO	Fig. 2
PF1E	92	82	65	52	68	4.4	4 x 20mm ISO	Fig. 2
PN1C	72	64	56	36	50	4.4	4 x 20mm ISO	Fig. 2
PN1G	72	64	69	36	50	4.4	4 x 20mm ISO	Fig. 2

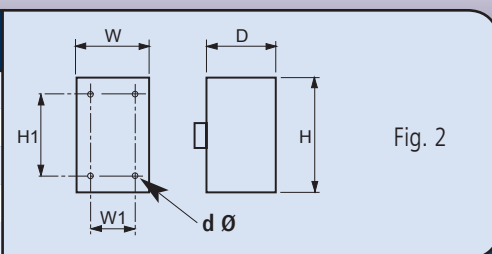

# TECHNICAL DATA

Switch Type	Thermal Rating	Insulation Voltage, U <sub>i</sub>	Rated operating Current & power				Short Circuit Protection	Terminal Capacity		
			Operational current, I <sub>e</sub>		Operational Power, 3 ph.					
			AC-15	AC-21A	AC-3	AC-23A				
	Enclosed rating I <sub>th</sub>	V	110V 220-240V 380-440V	690V	220-240V 380-440V	230-240V 380-440V	Max. fuse gL/gG char.	Single core/ stranded wire.	Flexible wire, with sleeve.	Terminal bolt for Cu bar/lug.
			A	A	kW					
<b>Switch-disconnectors - selection data in accordance with: IEC 60947, IEC 60204, BS EN 60947, BS EN 60204</b>										
KG10	20	690	- - -	20	2.2 3.7	3 5.5	20	2.5	1.5	-
KG20	25	690	- - -	25	4 5.5	5.5 7.5	35	6	4	-
KG32	32	690	- - -	32	5.5 7.5	5.5 11	35	6	4	-
KG41	40	690	- - -	40	7.5 11	7.5 15	50	16	10	-
KG64	63	690	- - -	63	11 18.5	11 22	63	16	10	-
KG80	80	690	- - -	80	15 22	18.5 30	80	50	35	-
KG100	100	690	- - -	100	18.5 30	22 37	100	50	35	-
KG105	125	690	- - -	125	22 37	25 45	125	50	35	-
KG125	125	1000 <sup>1)</sup>	- - -	125	22 37	30 45	125	95	70	-
KG160	160	1000 <sup>1)</sup>	- - -	160	30 45	30 55	160	95	70	-
KG210	200	1000 <sup>1)</sup>	- - -	200	37 55	37 75	200	185	120	-
KG250	250	1000 <sup>1)</sup>	- - -	250	37 55	37 90	250	185	120	-
KG315	315	1000 <sup>1)</sup>	- - -	315	45 75	55 110	315	185	120	-
KH16	16	800 <sup>1)</sup>	- - -	16	3 5.5	4.5 7.5	25	6	4	-
KH20	20	800 <sup>1)</sup>	- - -	20	3.5 6.5	5.5 10	32	6	4	-
KH25	25	800 <sup>1)</sup>	- - -	25	4 7.5	7 12	35	6	4	-
KH32	32	800 <sup>1)</sup>	- - -	32	5.5 11	9 16	35	10	6	-
KH40	40	800 <sup>1)</sup>	- - -	40	7.5 15	11 20	50	10	6	-
KH63	63	1000 <sup>1)</sup>	- - -	63	11 22	18.5 30	80	35	25	-
KH80	80	1000 <sup>1)</sup>	- - -	80	15 30	23 40	100	35	25	-
KH85	100	1000 <sup>1)</sup>	- - -	100	3) 3)	3) 3)	100	35	25	-
UK20	20	690	5 5 4	20	3 5.5	3.7 7.5	25	2x2.5	2x2.5	-
UK25	25	690	8 8 5	25	4 7.5	5.5 11	35	2x4	2x2.5	-
UK32	32	690	12 12 6	32	5.5 11	7.5 15	35	2x6	2x4	-
UK250/A	250	1000	- - -	250	- -	75 140	315	150		M8
UK315/A	315	1000	- - -	315	- -	100 160	500	240		M10
UK400/A	400	1000	- - -	400	- -	132 220	500	240		M10
UK630/A	630	1000	- - -	630	- -	200 355	800	400/2x155		M12
UK800/A	800	1000	- - -	800	- -	250 450	800	500/2x240		M12
UK1000/A	1000	1000	- - -	1000	- -	- 560	1250	630/2x400		M12
UK1250/A	1250	1000	- - -	1250	- -	- 710	1250	2x400		M12
C200-4	200	690	- - -	200	22 37	37 75	200	95	95	M8
C316 (6 pole) (in RB10, MB10, SB10 encl)	275	1000	- - -	275	37 55	75 132	315	150	150	M12
C316 (6 pole) (in RB29, MB29, SB29 encl)	315	1000	- - -	315	37 55	75 132	315	185	150	M12
C316 (3 + 4 pole) (in GP27 encl)	315	1000	- - -	315	37 55	75 132	315	150	150	M12
<b>Switch &amp; Control Stations - selection data in accordance with: IEC 60947, BS EN 60947.</b>										
CA4	10	440	- 2.5 1.5	10	0.55 2.2	0.75 3	10	2x1.5	2x1.5	-
CA25	32	690	12 12 6	32	5.5 11	7.5 15	35	2x6	2x4	-
C32	50	690	16 16 7	40	7.5 15	11 22	63	2x10	2x6	-
C42	63	690	- - -	63	11 18.5	15 30	80	2x16	2x10	-
C80	115	690	- - -	100	15 30	30 45	125	35	25	-
C125	150	690	- - -	150	22 37	37 75	200	70	50	-
C200-4	200	690	- - -	200	22 37	37 75	200	95	95	M8
C315 (In MB10 encl)	275	690	- - -	275	37 55	75 132	315	150	150	M12
C315 (In MB29 encl)	315	690	- - -	315	37 55	75 132	315	185	150	M12
KN1/KN2/KN3/KN10/CA10	20	690	5 5 4	20	3 5.5	3.7 7.5	25	2x2.5	2x2.5	-
KN4	20	690	- - -	-	3 <sup>2)</sup> 5.5 <sup>2)</sup>	- -	25	2x2.5	2x2.5	-
KN5/KN6	25	690	8 8 5	25	4 7.5	5.5 11	35	2x4	2x2.5	-
KN7/KN8	32	690	14 14 6	32	5.5 11	7.5 15	50	2x6	2x4	-
P N/P SN	6	500	6 6 4	-	- -	- -	10	2.5	1.5	-

Notes: 1) Only valid for no-load switching (AC-20A) above 690v.  
2) 1 phase, 240v, rating = 1.5kW.

3) KH85 is only available as 2 pole changeover switch.  
Single phase rating @240v: AC-3 = 10kW, 62A. AC-23A = 11kW, 68A.

# DEGREES OF PROTECTION

## IP Codes

A coding system is defined by BS EN 60529 for the classification of degrees of protection provided by enclosures of electrical equipment against solid objects and water. This coding comprises the letters 'IP' followed by a two digit code as follows:-

**IP 6 5**

**Defines protection against solid objects and access to hazardous parts.**

**Defines protection against water.**

Degrees of protection indicated by a number up to and including '6' implies compliance with the requirements for all lower numbers. For a code with a second digit of 7 or 8, a second code must be stated to specify protection against water jets or spray, eg IP66/IP67.

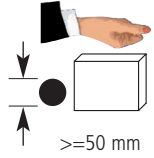
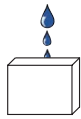
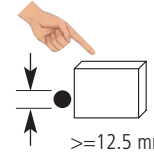
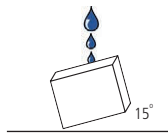
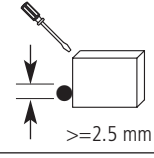
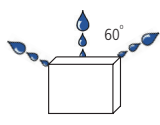
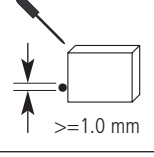
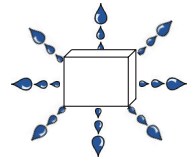
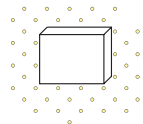
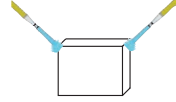
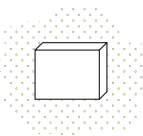
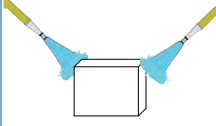
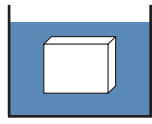
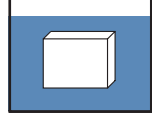
1st Digit	Protection against solid objects and access to hazardous parts.	2nd Digit	Protection against water
0	No protection	0	No protection
1	 No ingress by solid objects $\geq 50$ mm dia nor access to hazardous parts with the back of the hand	1	 Vertically falling drops of water shall have no harmful effect.
2	 No ingress by solid objects $\geq 12.5$ mm dia nor access to hazardous parts with a finger.	2	 Vertically falling drops of water shall have no harmful effect when the enclosure is tilted at any angle up to $15^\circ$ from vertical.
3	 No ingress by solid objects $\geq 2.5$ mm dia nor access to hazardous parts with a tool.	3	 Water sprayed at up to $60^\circ$ from the vertical shall have no harmful effect.
4	 No ingress by solid objects $\geq 1.0$ mm dia nor access to hazardous parts with a wire.	4	 Water splashed from any direction shall have no harmful effect.
5	 Dust protected. Ingress of dust is not completely prevented, but there should be no harmful deposits. No access to hazardous parts with a wire.	5	 Jets of water projected from any direction shall have no harmful effect.
6	 Dust-tight. No ingress of dust. No access to hazardous parts with a wire.	6	 Strong jets of water projected from any direction shall have no harmful effect.
		7	 Temporary immersion in water shall not result in ingress of harmful quantities of water.
		8	 Continuous immersion in water shall not result in ingress of harmful quantities of water.

Reference should be made to BS EN 60529:1992 for full details concerning test and acceptance criteria.

**Specification for IP69K** - The IP69K rating is for applications where high pressure and high temperature washdown is used to sanitize equipment, prescribed by Germany standard DIN 40050 PART9. Products rated to IP69K must be able to withstand high-pressure and steam cleaning. • The test specifies a spray nozzle that is fed with  $80^\circ\text{C}$  water at 80–100 bar (~1160-1450) and a flow rate of 14–16 L/min. • The nozzle is held 10–15 cm from the tested device at angles of  $0^\circ$ ,  $30^\circ$ ,  $60^\circ$  and  $90^\circ$  for 30 seconds each. • The test device sits on a turntable that rotates once every 12 seconds.

# SWITCH DISCONNECTORS

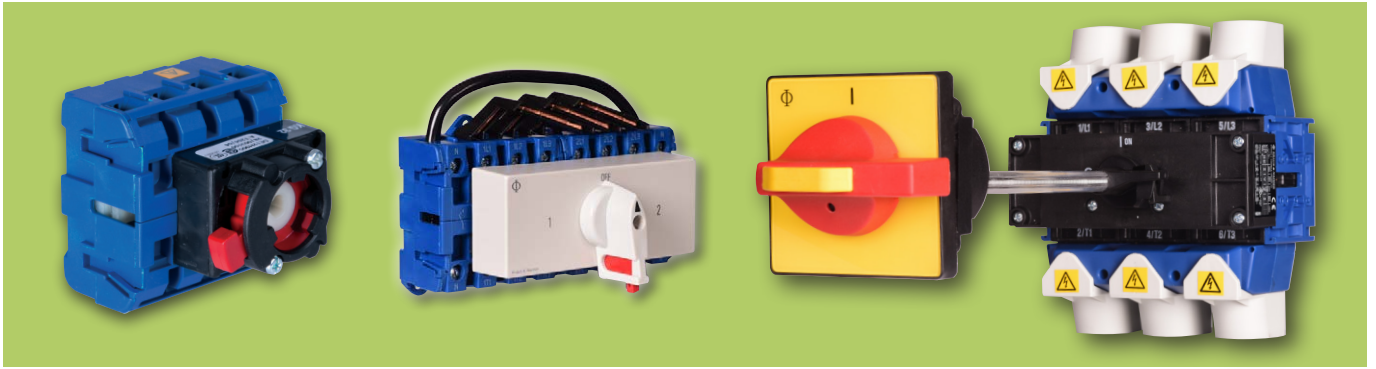

This section contains the most popular Kraus & Naimer Blue Line switch-disconnectors including our range of main/emergency-off switches, main switches and changeover switches.

## Contents

Page

### Off - On Switch-disconnectors

#### Main/Emergency-Off Switch

Front Panel Mounting Single Hole Fixing Handle	32
Front Panel Mounting 4 Hole Fixing Handle	33
Base Mounting Single Hole Fixing Handle	34
Base Mounting 4 Hole Fixing Handle	35
<b>Main/Emergency-Off Switch with Defeatable Door Interlock</b>	
Base Mounting Single Hole Fixing Handle	36
Base Mounting 4 Hole Fixing Handle	37

### Changeover Switch-disconnectors

#### Changeover Switch with Centre Off

Base Mounting 4 Hole Fixing Handle 2, 3 & 4 pole 16A to 160A	38
Base Mounting, suitable for 45mm distribution board cutout	38

### Optional Extras

Side Mounted Earth Terminal	39
Side Mounted Neutral Terminal	39
Side Mounted Auxiliary Contact	39
Mounting Tool	39
Terminal Covers	39

### Technical Data, dimensions & general information

Technical Data	40
Connection Diagrams	41
Dimensions	42 to 47



## Main/Emergency-Off Switch - 2, 3 & 4 Pole Front Panel Mounting Single Hole Fixing Handle 20A to 32A

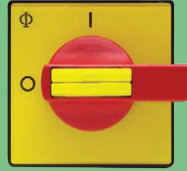

- red/yellow padlockable handle
- black/silver handle available for use as main switch
- fingerproof terminals
- IP66/67 front protection
- variations on auxiliaries available plus add-on auxiliary blocks (see page 39)
- front plate size: 48mm x 48mm

### Without Auxiliaries

Ie AC-21A	2 Pole	3 Pole	3 Pole + Solid Neutral	4 Pole (3ph + Sw N <sup>2</sup> )
20A	KG10A T202/04 FT2	KG10A T203/04 FT2		KG10A T204/04 FT2
25A		KG20A T203/04 FT2	KG20A T207/04 FT2	KG20A T204/04 FT2
32A		KG32A T203/04 FT2	KG32A T207/04 FT2	KG32A T204/04 FT2

### With Auxiliaries<sup>1</sup>

Ie AC-21A	2 Pole	3 Pole	3 Pole + Solid Neutral	4 Pole (3ph + Sw N <sup>2</sup> )
20A		KG10A T203/GBA319 FT2		KG10A T204/GBA330 FT2
25A		KG20A T203/GBA320 FT2	KG20A T207/GBA325 FT2	KG20A T204/GBA330 FT2
32A		KG32A T203/GBA320 FT2	KG32A T207/GBA325 FT2	KG32A T204/GBA330 FT2

#### Notes

1) The following auxiliary contacts are provided:-

KG10A 1 n.o. (early break) + 1 n.c.  
KG20A, KG32A 2 n.o. (early break)



2) Switched neutral pole is early make/late break

Technical data - Page 40

Connection diagram - Page 41

Dimensions - KG - Page 42



- red/yellow padlockable handle
  - KG10A to KG160 
  - KG210 to KG315 
- black / silver handle available
- IP66/67 front protection
- fingerproof terminals - KG10A to KG64B
- incoming terminal cover - KG80 to KG315 (KG210 to KG315 incl. outgoing cover)
- variations on auxiliaries available plus add - on auxiliary blocks (see page 39)
- front plate size;
  - KG10A to KG32A: 48mm x 48mm
  - KG41B to KG105: 64mm x 64mm
  - KG125 to KG315: 88mm x 88mm

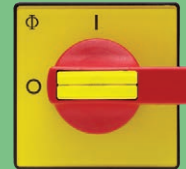

### Without Auxiliaries

le AC-21A	3 Pole	4 Pole (3ph + Sw N <sup>3</sup> )
20A	KG10A T203/01 E	KG10A T204/01 E
25A	KG20A T203/01 E	KG20A T204/01 E
32A	KG32A T203/01 E	KG32A T204/01 E
40A	KG41B T203/GBA306 E	KG41B T204/01 E
63A	KG64B T203/GBA306 E	KG64B T204/01 E
80A	KG80 T203/GBA306 E	KG80 T204/01 E
100A	KG100 T203/GBA306 E	KG100 T204/01 E
125A	KG105 T203/GBA306 E	KG105 T204/01 E
125A	KG125 <sup>2</sup> T203/01 E	KG125 <sup>2</sup> T204/01 E
160A	KG160 T203/01 E	KG160 T204/01 E
200A	KG210 T203/05 E	KG210 T204/05 E
250A	KG250 T203/05 E	KG250 T204/05 E
315A	KG315 T203/05 E	KG315 T204/05 E

### With Auxiliaries<sup>1</sup>

le AC-21A	3 Pole	4 Pole (3ph + Sw N <sup>3</sup> )
20A	KG10A T203/GBA315 E	KG10A T204/GBA415 E
25A	KG20A T203/GBA315 E	KG20A T204/GBA415 E
32A	KG32A T203/GBA315 E	KG32A T204/GBA415 E
40A	KG41B T203/GBA353 E	KG41B T204/GBA426 E
63A	KG64B T203/GBA353 E	KG64B T204/GBA426 E
80A	KG80 T203/GBA353 E	KG80 T204/GBA426 E
100A	KG100 T203/GBA353 E	KG100 T204/GBA426 E
125A	KG105 T203/GBA353 E	KG105 T204/GBA426 E
125A	KG125 <sup>2</sup> T203/GBA368 E	KG125 <sup>2</sup> T204/GBA045 E
160A	KG160 T203/GBA025 E	KG160 T204/GBA045 E
200A	KG210 T203/GBA025 E	KG210 T204/GBA035 E
250A	KG250 T203/GBA025 E	KG250 T204/GBA035 E
315A	KG315 T203/GBA025 E	KG315 T204/GBA035 E

#### Notes

1) The following auxiliary contacts are provided:-  
 KG10A 1 n.o. (early break) + 1 n.c.  
 KG20A to KG105 2 n.o. (early break)  
 KG125 - KG315 2 n.o. auxiliary (early break) + 2 n.c.

2) Suitable for applications requiring larger cable termination

3) Switched neutral pole is early make/late break

Technical data - Page 40

Connection diagram - Page 41

Dimensions - KG - Page 42



## Main/Emergency-Off Switch - 3, 4 & 6 Pole Base Mounting Single Hole Fixing Handle 20A to 125A

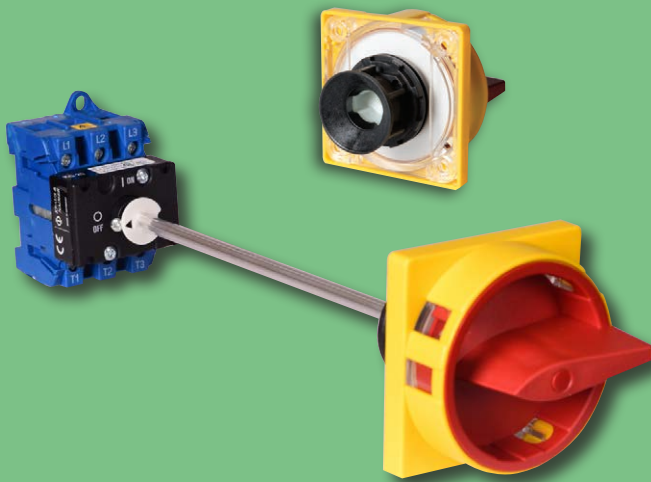

- red/yellow padlockable handle
- black/silver handle available for use as main switch
- door interlock
- adjustable metal operating shaft 200mm long, switches with alternative shaft lengths available on request
- IP66 front protection
- fingerproof terminals -KG10A to KG64B
- incoming terminal cover -KG80 to KG105
- suitable for DIN rail mounting
- variations on auxiliaries available plus add - on auxiliary blocks (see page 39)
- front plate size
  - KG10A to KG32A: 48mm x 48mm
  - KG41B to KG105: 64mm x 64mm

### Without Auxiliaries

le AC-21A	3 Pole	3 Pole + Solid Neutral	4 Pole (3ph + Sw N <sup>2</sup> )	6 Pole
20A	KG10A T203/GBA352 VE		KG10A T204/GBA237 VE	
25A	KG20A T203/GBA352 VE	KG20A T207/GBA220 VE	KG20A T204/GBA237 VE	KG20B T206/GBA230 VE
32A	KG32A T203/GBA352 VE	KG32A T207/GBA220 VE	KG32A T204/GBA237 VE	KG32B T206/GBA230 VE
40A	KG41B T203/GBA452 VE	KG41B T207/GBA240 VE	KG41B T204/GBA447 VE	KG41B T206/GBA410 VE
63A	KG64B T203/GBA452 VE	KG64B T207/GBA240 VE	KG64B T204/GBA447 VE	KG64B T206/GBA410 VE
80A	KG80 T203/GBA452 VE	KG80 T207/GBA240 VE	KG80 T204/GBA447 VE	KG80 T206/GBA410 VE
100A	KG100 T203/GBA452 VE	KG100 T207/GBA240 VE	KG100 T204/GBA447 VE	KG100 T206/GBA410 VE
125A	KG105 T203/GBA452 VE	KG105 T207/GBA240 VE	KG105 T204/GBA447 VE	KG105 T206/GBA410 VE

### With Auxiliaries<sup>1</sup>

le AC-21A	3 Pole	3 Pole + Solid Neutral	4 Pole (3ph + Sw N <sup>2</sup> )	6 Pole
20A	KG10A T203/GBA372 VE		KG10A T204/GBA247 VE	
25A	KG20A T203/GBA372 VE	KG20A T207/GBA225 VE	KG20A T204/GBA247 VE	KG20B T206/GBA236 VE
32A	KG32A T203/GBA372 VE	KG32A T207/GBA225 VE	KG32A T204/GBA247 VE	KG32B T206/GBA228 VE
40A	KG41B T203/GBA462 VE	KG41B T207/GBA245 VE	KG41B T204/GBA457 VE	KG41B T206/GBA415 VE
63A	KG64B T203/GBA462 VE	KG64B T207/GBA245 VE	KG64B T204/GBA457 VE	KG64B T206/GBA415 VE
80A	KG80 T203/GBA462 VE	KG80 T207/GBA245 VE	KG80 T204/GBA457 VE	KG80 T206/GBA415 VE
100A	KG100 T203/GBA462 VE	KG100 T207/GBA245 VE	KG100 T204/GBA457 VE	KG100 T206/GBA415 VE
125A	KG105 T203/GBA462 VE	KG105 T207/GBA245 VE	KG105 T204/GBA457 VE	KG105 T206/GBA415 VE

#### Notes

1) The following auxiliary contacts are provided:-

KG10A                    1 n.o. (early break) + 1 n.c.  
 KG20A to KG105      2 n.o. (early break)



Technical data                    - Page 40

Connection diagram           - Page 41

Dimensions - KG                - Page 43

2) Switched neutral pole is early make/late break

## Main/Emergency-Off Switch - 3, 4 & 6 Pole Base Mounting Four Hole Fixing Handle 20A to 315A

- red / yellow padlockable handle  
-KG10A to KG160 
- -KG210 to KG315 
- black handle available
- door interlock
- adjustable metal operating shaft 200mm long (KG125 to KG315 300mm long), switches with alternative shaft lengths available
- IP66/67 front protection
- fingerproof terminals -KG10A to KG64B
- incoming terminal cover -KG80 to KG315 (KG210 to KG315 incl. outgoing cover)
- suitable for DIN rail mounting - up to KG105
- variations on auxiliaries available plus add - on auxiliary blocks (see page 39)
- front plate size -KG10A to KG32A: 48mm x 48mm -KG20B to KG105: 64mm x 64mm -KG125 to KG315: 88mm x 88mm

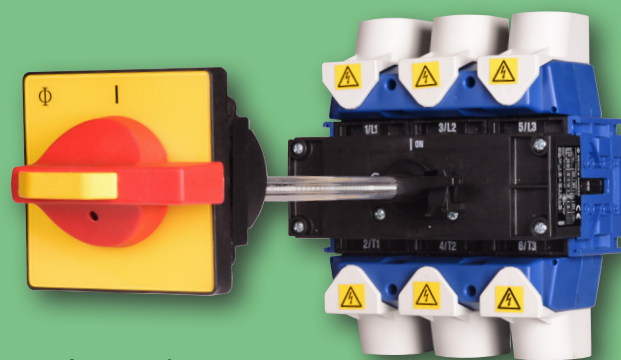

### Without Auxiliaries

le AC-21A	3 Pole		3 Pole + Solid Neutral		4 Pole (3ph + Sw N <sup>3</sup> )		6 Pole	
20A	KG10A T203/GBA430 VE				KG10A T204/GBA450 VE			
25A	KG20A T203/GBA430 VE		KG20A T207/GBA140 VE		KG20A T204/GBA450 VE		KG20B T206/GBA221 VE	
32A	KG32A T203/GBA430 VE		KG32A T207/GBA140 VE		KG32A T204/GBA450 VE		KG32B T206/GBA221 VE	
40A	KG41B T203/GBA430 VE		KG41B T207/GBA140 VE		KG41B T204/GBA450 VE		KG41B T206/GBA221 VE	
63A	KG64B T203/GBA430 VE		KG64B T207/GBA140 VE		KG64B T204/GBA450 VE		KG64B T206/GBA221 VE	
80A	KG80 T203/GBA430 VE		KG80 T207/GBA140 VE		KG80 T204/GBA450 VE		KG80 T206/GBA221 VE	
100A	KG100 T203/GBA430 VE		KG100 T207/GBA140 VE		KG100 T204/GBA450 VE		KG100 T206/GBA221 VE	
125A	KG105 T203/GBA430 VE		KG105 T207/GBA140 VE		KG105 T204/GBA450 VE		KG105 T206/GBA221 VE	
125A	KG125 <sup>2</sup> T203/GBA050 VE		KG125 T207/GBA151 VE		KG125 <sup>2</sup> T204/GBA100 VE		KG125 <sup>2</sup> T206/GBA061 VE	
160A	KG160 T203/GBA050 VE		KG160 T207/GBA151 VE		KG160 T204/GBA100 VE		KG160 <sup>2</sup> T206/GBA061 VE	
200A	KG210 T203/GBA015 VE		KG210 T207/GBA156 VE		KG210 T204/GBA020 VE			
250A	KG250 T203/GBA015 VE		KG250 T207/GBA156 VE		KG250 T204/GBA020 VE			
315A	KG315 T203/GBA015 VE		KG315 T207/GBA157 VE		KG315 T204/GBA020 VE			

### With Auxiliaries<sup>1</sup>

le AC-21A	3 Pole		3 Pole + Solid Neutral		4 Pole (3ph + Sw N <sup>3</sup> )		6 Pole	
20A	KG10A T203/GBA435 VE				KG10A T204/GBA455 VE			
25A	KG20A T203/GBA435 VE		KG20A T207/GBA145 VE		KG20A T204/GBA455 VE		KG20B T206/GBA225 VE	
32A	KG32A T203/GBA435 VE		KG32A T207/GBA145 VE		KG32A T204/GBA455 VE		KG32B T206/GBA225 VE	
40A	KG41B T203/GBA435 VE		KG41B T207/GBA145 VE		KG41B T204/GBA455 VE		KG41B T206/GBA225 VE	
63A	KG64B T203/GBA435 VE		KG64B T207/GBA145 VE		KG64B T204/GBA455 VE		KG64B T206/GBA225 VE	
80A	KG80 T203/GBA435 VE		KG80 T207/GBA145 VE		KG80 T204/GBA455 VE		KG80 T206/GBA225 VE	
100A	KG100 T203/GBA435 VE		KG100 T207/GBA145 VE		KG100 T204/GBA455 VE		KG100 T206/GBA225 VE	
125A	KG105 T203/GBA435 VE		KG105 T207/GBA145 VE		KG105 T204/GBA455 VE		KG105 T206/GBA225 VE	
125A	KG125 <sup>2</sup> T203/GBA055 VE		KG125 T207/GBA150 VE		KG125 <sup>2</sup> T204/GBA105 VE		KG125 <sup>2</sup> T206/GBA070 VE	
160A	KG160 T203/GBA055 VE		KG160 T207/GBA150 VE		KG160 T204/GBA105 VE		KG160 T206/GBA070 VE	
200A	KG210 T203/GBA030 VE		KG210 T207/GBA155 VE		KG210 T204/GBA040 VE			
250A	KG250 T203/GBA030 VE		KG250 T207/GBA155 VE		KG250 T204/GBA040 VE			
315A	KG315 T203/GBA030 VE		KG315 T207/GBA155 VE		KG315 T204/GBA040 VE			

#### Notes

1) The following auxiliary contacts are provided:-  
 KG10A 1 n.o. (early break) + 1 n.c.  
 KG20A to KG105 2 n.o. (early break)  
 KG125 to KG315 2 n.o. (early break) + 2 n.c

2) Suitable for applications requiring larger cable termination  
 3) Switched neutral pole is early make/late break

Technical data - Page 40

Connection diagram - Page 41

Dimensions - KG - Page 43-44



## Main/Emergency-Off Switch With Defeatable Door Interlock- 3 & 4 Pole Base Mounting Single Hole Fixing Handle 25A - 160A

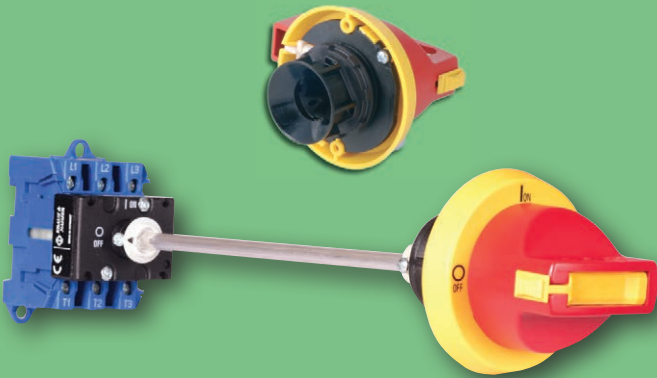

- red / yellow padlockable handle
- black handle available for use as main switch
- IP66/67 front protection
- metal operating shaft
  - KG20B to KG105 200mm long
  - KG125 to KG160 300mm long
- switches with alternate shaft length available
- fingerproof terminals - KG20B & KG64B
- incoming terminal cover - KG80 to KG160
- suitable for DIN rail mounting up to KG105

### Without Auxiliaries

le AC-21A	3 Pole	4 Pole (3ph + Sw N <sup>2</sup> )
25A	KG20B T203/GBA340 VE	KG20B T204/GBA350 VE
32A	KG32B T203/GBA340 VE	KG32B T204/GBA350 VE
40A	KG41B T203/GBA370 VE	KG41B T204/GBA380 VE
63A	KG64B T203/GBA370 VE	KG64B T204/GBA380 VE
80A	KG80 T203/GBA370 VE	KG80 T204/GBA380 VE
100A	KG100 T203/GBA370 VE	KG100 T204/GBA380 VE
125A	KG105 T203/GBA370 VE	KG105 T204/GBA380 VE
125A	KG125 <sup>3</sup> T203/GBA180 VE	KG125 <sup>3</sup> T204/GBA190 VE
160A	KG160 T203/GBA180 VE	KG160 T204/GBA190 VE

### With Auxiliaries<sup>1</sup>

le AC-21A	3 Pole	4 Pole (3ph + Sw N <sup>2</sup> )
25A	KG20B T203/GBA345 VE	KG20B T204/GBA355 VE
32A	KG32B T203/GBA345 VE	KG32B T204/GBA355 VE
40A	KG41B T203/GBA375 VE	KG41B T204/GBA385 VE
63A	KG64B T203/GBA375 VE	KG64B T204/GBA385 VE
80A	KG80 T203/GBA375 VE	KG80 T204/GBA385 VE
100A	KG100 T203/GBA375 VE	KG100 T204/GBA385 VE
125A	KG105 T203/GBA375 VE	KG105 T204/GBA385 VE
125A	KG125 <sup>3</sup> T203/GBA185 VE	KG125 <sup>3</sup> T204/GBA195 VE
160A	KG160 T203/GBA185 VE	KG160 T204/GBA195 VE

#### Note:

When required for maintenance purposes, qualified personnel can defeat the door interlock and enable the panel door to be opened whilst the switch is in the 'ON' position.

Door clutch will accept 3mm misalignment between switch shaft and door mounted handle.

In normal operation the switch handle is padlockable in the OFF position only and interlocked with the shaft in the ON position to prevent opening of the panel door. Shaft and handle are also interlocked in the OFF position if a padlock is fitted to the handle with the panel door closed.

#### Notes

- 1) The following auxiliary contacts are provided:-
- |                |                               |                    |           |
|----------------|-------------------------------|--------------------|-----------|
| KG10A          | 1 n.o. (early break) + 1 n.c. | Technical data     | - Page 40 |
| KG20A to KG105 | 2 n.o. (early break)          | Connection diagram | - Page 41 |
|                |                               | Dimensions - KG    | - Page 43 |
- 2) Switched neutral pole is early make/late break
- 3) Suitable for applications requiring larger cable terminations

## Base Mounting - Defeatable Door Interlock

### Main/Emergency-Off Switch With Defeatable Door Interlock- 3 , 4 & 6 Pole Base Mounting Four Hole Fixing Handle 40A - 315A

- red / yellow padlockable handle
- black / silver handle available for use as main switch
- IP66 front protection
- metal operating shaft
  - KG41B to KG105 200mm long
  - KG125 to KG315 300mm long
- switches with alternative shaft length available
- fingerproof terminals - KG41B & KG64B
- incoming terminal cover - KG80 to KG315  
(KG210 to KG315 incl. outgoing cover)
- suitable for DIN rail mounting up to KG105
- front plate size 88 x 88mm

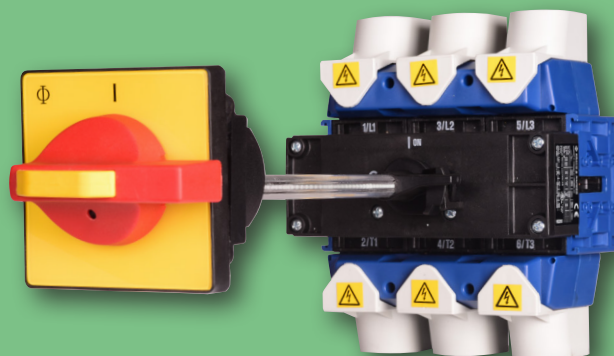

#### Without Auxiliaries

le AC-21A	3 Pole	4 Pole (3ph + Sw N <sup>2</sup> )	6 Pole
40A	KG41B T203/GBA330 VE	KG41B T204/GBA060 VE	KG41B T206/GBA121 VE
63A	KG64B T203/GBA330 VE	KG64B T204/GBA060 VE	KG64B T206/GBA121 VE
80A	KG80 T203/GBA330 VE	KG80 T204/GBA060 VE	KG80 T206/GBA121 VE
100A	KG100 T203/GBA330 VE	KG100 T204/GBA060 VE	KG100 T206/GBA121 VE
125A	KG105 T203/GBA330 VE	KG105 T204/GBA060 VE	KG105 T206/GBA121 VE
125A	KG125 T203/GBA080 VE	KG125 T204/GBA090 VE	KG125 T206/GBA104 VE
160A	KG160 T203/GBA080 VE	KG160 T204/GBA090 VE	KG160 T206/GBA104 VE
200A	KG210 T203/GBA080 VE	KG210 T204/GBA090 VE	
250A	KG250 T203/GBA080 VE	KG250 T204/GBA090 VE	
315A	KG315 T203/GBA080 VE	KG315 T204/GBA090 VE	

#### With Auxiliaries<sup>1</sup>

le AC-21A	3 Pole	4 Pole (3ph + Sw N <sup>1</sup> )	6 Pole
40A	KG41B T203/GBA335 VE	KG41B T204/GBA065 VE	KG41B T206/GBA125 VE
63A	KG64B T203/GBA335 VE	KG64B T204/GBA065 VE	KG64B T206/GBA125 VE
80A	KG80 T203/GBA335 VE	KG80 T204/GBA065 VE	KG80 T206/GBA125 VE
100A	KG100 T203/GBA335 VE	KG100 T204/GBA065 VE	KG100 T206/GBA125 VE
125A	KG105 T203/GBA335 VE	KG105 T204/GBA065 VE	KG105 T206/GBA125 VE
125A	KG125 <sup>3</sup> T203/GBA085 VE	KG125 T204/GBA095 VE	KG125 T206/GBA105 VE
160A	KG160 T203/GBA085 VE	KG160 T204/GBA095 VE	KG160 T206/GBA105 VE
200A	KG210 T203/GBA085 VE	KG210 T204/GBA095 VE	
250A	KG250 T203/GBA085 VE	KG250 T204/GBA095 VE	
315A	KG315 T203/GBA085 VE	KG315 T204/GBA095 VE	

#### Notes

1) The following auxiliary contacts are provided:- Technical data - Page 40

KG10A 1 n.o. (early break) + 1 n.c. Connection diagram - Page 41

KG20A to KG105 2 n.o. (early break) Dimensions - KG - Page 43

KG125 to KG 315 2 n.o. (early break) + 2 n.c.

2) Switched neutral pole is early make/late break

3) Suitable for applications requiring larger cable terminations

#### Note:

When required for maintenance purposes, qualified personnel can use the simple tool provided to defeat the door interlock and enable the panel door to be opened whilst the switch is in the 'ON' position.

Door clutch will accept 5mm misalignment between switch shaft and door mounted handle.

In normal operation the switch handle is padlockable in the OFF position only and interlocked with the shaft in the ON position to prevent opening of the panel door. Shaft and handle are also interlocked in the OFF position if a padlock is fitted to the handle with the panel door closed.



## Changeover Switch, Centre Off - 2, 3 & 4 pole Base Mounting 4 Hole Fixing Handle

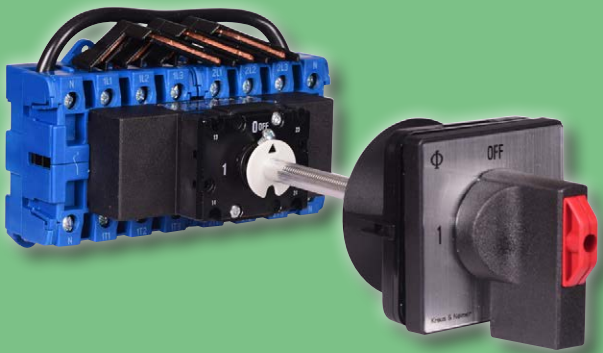

- black / silver padlockable handle
- door interlock
- IP66/67 front protection
- metal operating shaft
  - 120mm long KH16 to KH25, KG20B & KG32B
  - 130mm long KH32 to KH85, KG41B to KG105
  - 190mm long KG125 & KG160
- switches with alternate shaft lengths available.
- fingerproof terminals
  - KH16 to KH40
  - KG20B to KG64B
- suitable for DIN rail mounting up to KG105 and all KH switches
- front plate size
  - KH16 to KH85: 64mm x 64mm
  - KG20B to KG64B: 64mm x 64mm
  - KG80 to KG160 88mm x 88mm

Ie AC-21A	2 Pole	3 Pole + aux <sup>1)</sup>	4 Pole (3ph + Sw N <sup>2)</sup> + aux <sup>1)</sup>
16A	KH16 T902/GBA005 VE		
20A	KH20 T902/GBA005 VE		
25A	KH25 T902/GBA005 VE	KG20B T903/GBA005 VE	KG20B T904/GBA006 VE
32A	KH32 T902/GBA005 VE	KG32B T903/GBA005 VE	KG32B T904/GBA006 VE
40A	KH40 T902/GBA005 VE	KG41B T903/GBA005 VE	KG41B T904/GBA006 VE
63A	KH63 T902/GBA005 VE	KG64B T903/GBA005 VE	KG64B T904/GBA006 VE
80A	KH80 T902/GBA005 VE	KG80 T903/GBA005 VE	KG80 T904/GBA006 VE
100A	KH85 T902/GBA005 VE	KG100 T903/GBA005 VE	KG100 T904/GBA006 VE
125A		KG105 T903/GBA005 VE	KG105 T904/GBA006 VE
125A		KG125 T903/GBA010 VE	KG125 T904/GBA020 VE
160A		KG160 T903/GBA010 VE	KG160 T904/GBA020 VE

Technical data - Page 40  
 Connection diagram - Page 41  
 Dimensions – KG - Page 45  
 – KH - page 47

### Notes

1) 2-off volt-free, early break, auxiliary contacts are provided. One of these contacts closes in position 1 and the other contact closes in position 2. Both of the contacts are open in the Off position.

2) Switched neutral pole is early make/late break

3) Suitable for applications requiring larger cable termination

## Changeover Switch, Centre Off 2 & 4 pole - Base Mounting

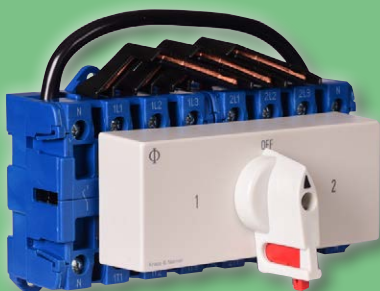

- grey handle, padlockable in OFF position
- grey escutcheon plate with "1 - OFF - 2" Legend
- escutcheon suitable for 45mm cut out
- fingerproof terminals
  - KH16 to KH40
  - KG41B & KG64B
- suitable for DIN rail mounting

Ie AC-21A	2 Pole	4 Pole (3ph + Sw N <sup>1)</sup> )
16A	KH16 T902/GBA011 VE2	
20A	KH20 T902/GBA011 VE2	
25A	KH25 T902/GBA011 VE2	
32A	KH32 T902/GBA011 VE2	
40A	KH40 T902/GBA011 VE2	KG41B T904/GBA035 VE2
63A	KH63 T902/GBA011 VE2	KG64B T904/GBA035 VE2
80A	KH80 T902/GBA011 VE2	KG80 T904/GBA035 VE2
100A	KH85 T902/GBA011 VE2	KG100 T904/GBA035 VE2
125A		KG105 T904/GBA035 VE2

### Notes

1) Switched neutral pole is early make/late break.

Technical data - Page 40

Connection diagram - Page 41

Dimensions – KG - Page 46

– KH - page 47

Side Mounted Earth Terminal



Switch Type	Code Number	
KG20A, KG32A, KG20B, KG32B	K0 H052/A	
KG41B, KG64B	K1 H052/B	
KG80 - KG105	K2 H052/C	

Side Mounted Neutral Terminal (Fully Rated)



Switch Type	Code Number	
KG20A, KG32A, KG20B, KG32B	K0 H053/A	
KG41B, KG64B	K1 H053/B	
KG80 - KG105	K2 H053/C	

Side Mounted Auxiliary Contacts



KG switches are also available with a variety of factory fitted auxiliary contacts. Please enquire for details

Switch Type	Contact Arrangements	Contact Rating		Code Number	
		AC-21A	AC-15 @ 110-240V		
<b>Panel Mounting E</b>					
KG20A, KG32A	1 n.o. + 1 n.c.	10A	2.5A	K0 H010/A11-E	
KG41B, KG64B	1 n.o. + 1 n.c.	16A	6A	K1 H010/A11-E	
KG80 - KG105	1 n.o. + 1 n.c.	16A	6A	K2 H010/A11-E	
KG125, KG160	2 n.o. + 1 n.c.	16A	6A	K3A H010/A21-E	
KG210 - KG315	2 n.o. + 1 n.c.	16A	6A	K3 H010/A21-E	
<b>Base Mounting VE</b>					
KG20B, KG32B	1 n.o. + 1 n.c.	10A	2.5A	K0 H010/A11-VE	
KG41B, KG64B	1 n.o. + 1 n.c.	16A	6A	K1 H010/A11-VE	
KG80 - KG105	1 n.o. + 1 n.c.	16A	6A	K2 H010/A11-VE	
KG125 - KG160	2 n.o. + 1 n.c.	16A	6A	K3A H010/A21-VE	
KG210 - KG315	2 n.o. + 1 n.c.	16A	6A	K3 H010/A21-VE	

Mounting Tool



Switch Type	Code Number	
For single hole mounting operators	S00 T170 09	

Terminal Covers

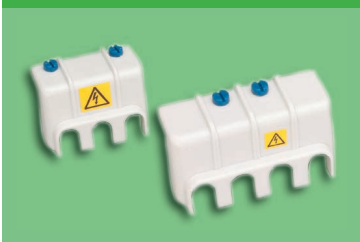

Switch Type	3 main terminals		4 main terminals	
	Code number		Code number	
KG10A	S0 M160/A12 K2		S0 M160/A12 K2	
KG20A&B/KG32A&B	K0 M160/3		K0 M160/4	
KG41B/KG64B	K1 M160/3		K1 M160/4	
KG80/KG105	K2 M160/3		K2 M160/4	
KG125/KG160	K3 M160/32		K3 M160/42	
KG210/KG315	K3 M160/30		K3 M160/40	
KH32/KH40			K1 M160/45 VE <sup>1)</sup>	
KH63/KH85			K1 M160/44 VE <sup>1)</sup>	

Notes

1) Suffix VE is applicable for base mounting switches only



Switch - Disconnectors

Switch Type	Thermal Rating	Insulation Voltage, U <sub>i</sub>	Rated Operating Current & Power								Short Circuit Protection	Terminal Capacity				
			Operational Current, I <sub>e</sub>				Operational Power					Max. fuse gL/gG char.	Single core/ stranded wire.	Flexible wire, with sleeve.	Terminal bolt for Cu bar/lug.	
Open rating			AC-15		AC-21A	AC-3		AC-23A		A	mm <sup>2</sup>					mm <sup>2</sup>
A	V		110v	220-240v	380-440v	690v	220-240v, 1 ph.	220-240v	380-440v	220-240v, 1 ph.	220-240v	380-440v				
Switch-disconnectors - selection data in accordance with: IEC 60947, IEC 60204, BS EN 60947, BS EN 60204																
KG10	20	690	-	-	-	20	1.1	2.2	3.7	1.5	3	5.5	20	2.5	1.5	-
KG20	25	690	-	-	-	25	1.5	4	5.5	2.2	5.5	7.5	35	6	4	-
KG32	32	690	-	-	-	32	2.2	5.5	7.5	3	5.5	11	35	6	4	-
KG41	40	690	-	-	-	40	3	7.5	11	4	7.5	15	50	16	10	-
KG64	63	690	-	-	-	63	4	11	18.5	5.5	11	22	63	16	10	-
KG80	80	690	-	-	-	80	7.5	15	22	10	18.5	30	80	50	35	-
KG100	100	690	-	-	-	100	8.5	18.5	30	11	22	37	100	50	35	-
KG105	125	690	-	-	-	125	-	22	37	-	25	45	125	50	35	-
KG125	125	1000 <sup>1)</sup>	-	-	-	125	-	22	37	-	30	45	125	95	70	-
KG160	160	1000 <sup>1)</sup>	-	-	-	160	-	30	45	-	30	55	160	95	70	-
KG210	200	1000 <sup>1)</sup>	-	-	-	200	-	37	55	-	37	75	200	185	120	-
KG250	250	1000 <sup>1)</sup>	-	-	-	250	-	37	55	-	37	90	250	185	120	-
KG315	315	1000 <sup>1)</sup>	-	-	-	315	-	45	75	-	55	110	315	185	120	-
KH16	16	800 <sup>1)</sup>	-	-	-	16	1.5	3	5.5	2	4.5	7.5	25	6	4	-
KH20	20	800 <sup>1)</sup>	-	-	-	20	2	3.5	6.5	2.5	5.5	10	32	6	4	-
KH25	25	800 <sup>1)</sup>	-	-	-	25	2.5	4	7.5	3.3	7	12	35	6	4	-
KH32	32	800 <sup>1)</sup>	-	-	-	32	3	5.5	11	4.2	9	16	35	10	6	-
KH40	40	800 <sup>1)</sup>	-	-	-	40	4.5	7.5	15	5.5	11	20	50	10	6	-
KH63	63	1000 <sup>1)</sup>	-	-	-	63	7.5	11	22	8.5	18.5	30	80	35	25	-
KH80	80	1000 <sup>1)</sup>	-	-	-	80	10	15	30	11	23	40	100	35	25	-
KH85	100	1000 <sup>1)</sup>	-	-	-	100	10	-	-	11	-	-	100	35	25	-
Auxiliary contacts - selection data in accordance with: IEC 60947, BS EN 60947.																
KG10	20	690	6	6	4	20	-	-	-	-	-	-	20	2.5	2.5	-
KG20 & KG32	10	500	2.5	2.5	1.5	10 <sup>2)</sup>	-	-	-	-	-	-	10	1.5	1.5	-
KG41 - KG105	16	690	6	6	3	16	-	-	-	-	-	-	16	2.5	2.5	-
KG125 - KG315	16	690	6	6	3	16	-	-	-	-	-	-	16	2.5	2.5	-

Switch Selection – Common Rating Data and Utilization Categories

Switch Rating or Utilization Category	Description
Rated insulation voltage, U <sub>i</sub>	Maximum value of operational voltage
Thermal current, I <sub>th</sub>	Maximum value of current that the switch can carry (not switch) when mounted in free air Max. ambient air temperature for stated value:- KG/KH switches : +50°C average over 24 hours with peaks up to 55°C
AC-3	For the selection of switches used for starting of squirrel cage motors and switching off during running
AC-15	For selection of switches to be used for the control of an a.c. electromagnetic load, e.g. contactor coils
AC-21A	For selection of switches required for switching of resistive loads, including moderate overloads
AC-23A	For selection of switches required for switching motor loads or other highly inductive loads
	Normal selection criteria for emergency-off switches for motors and switches used for safety isolation of motors (switch-disconnectors) such as Off/On, main or main/emergency-off switches.

Notes: 1) Only valid for no-load switching (AC-20A) above 690v.  
2) Max 500v



Switch - Disconnectors

Off - On

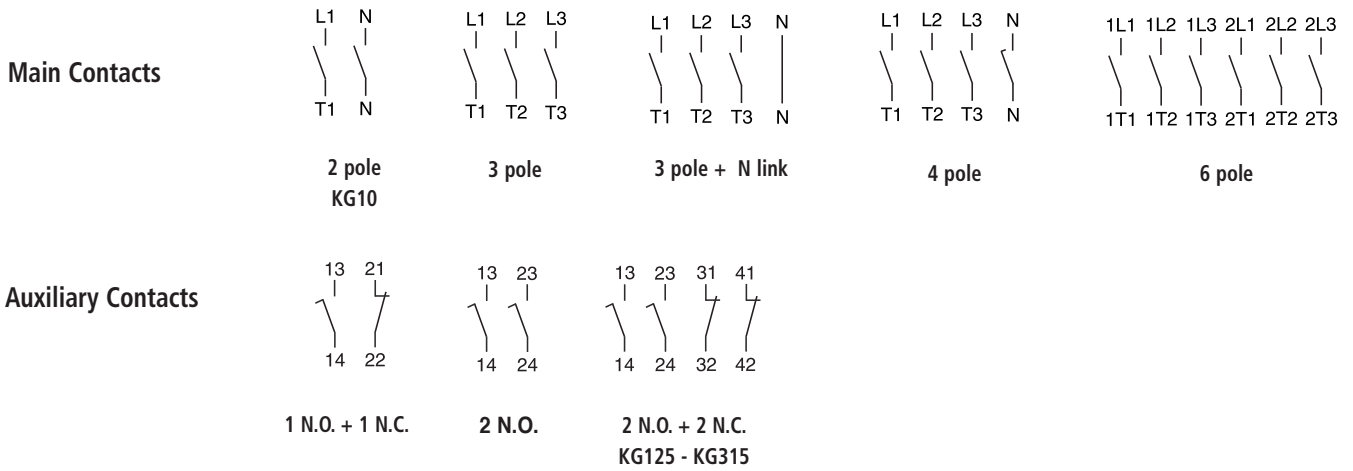

Changeover with Centre Off

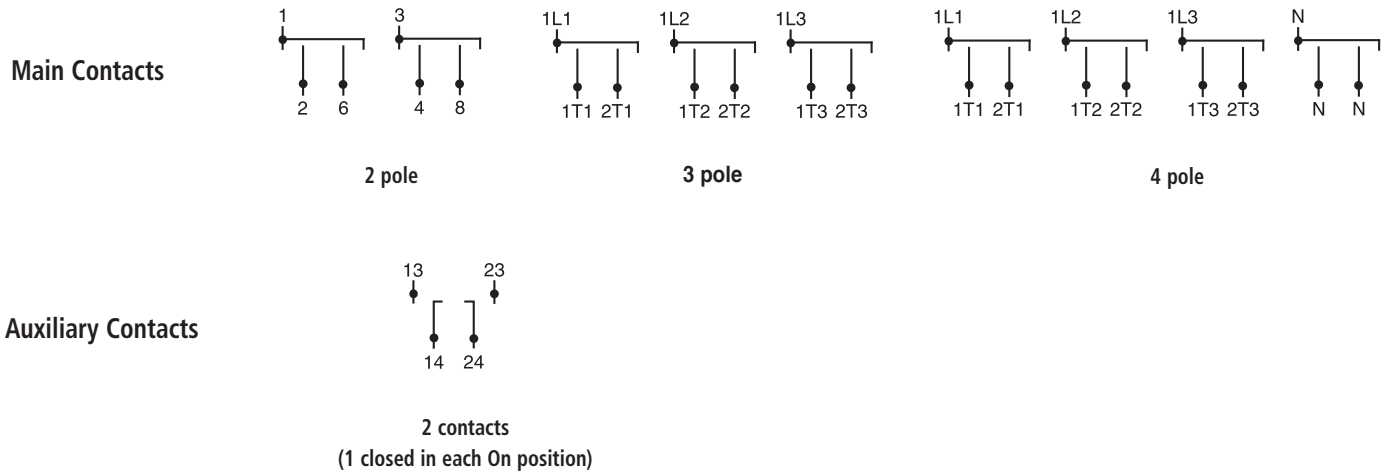

Side Mounting Auxiliary Contacts

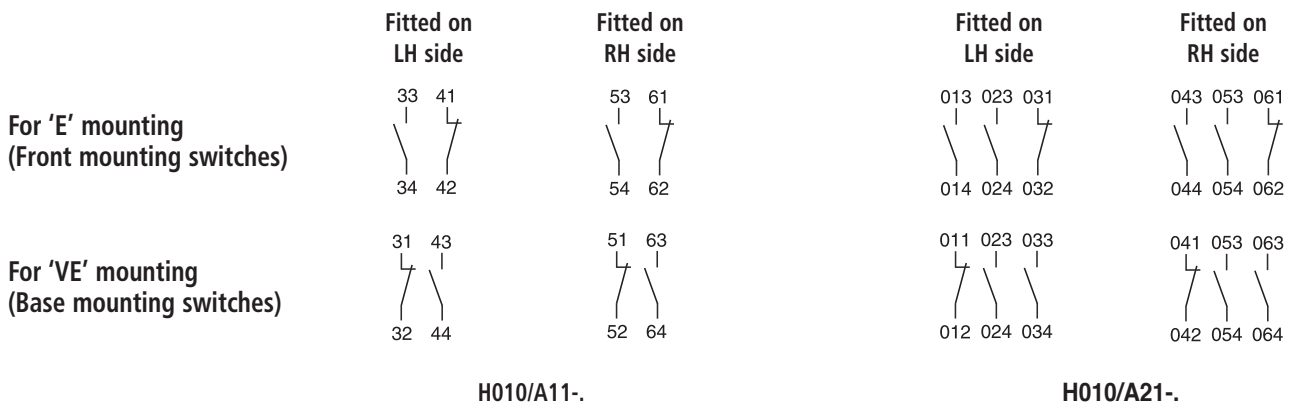



## KG Main / Emergency-Off Switches

### Front Panel Mounting - Single Hole Fixing

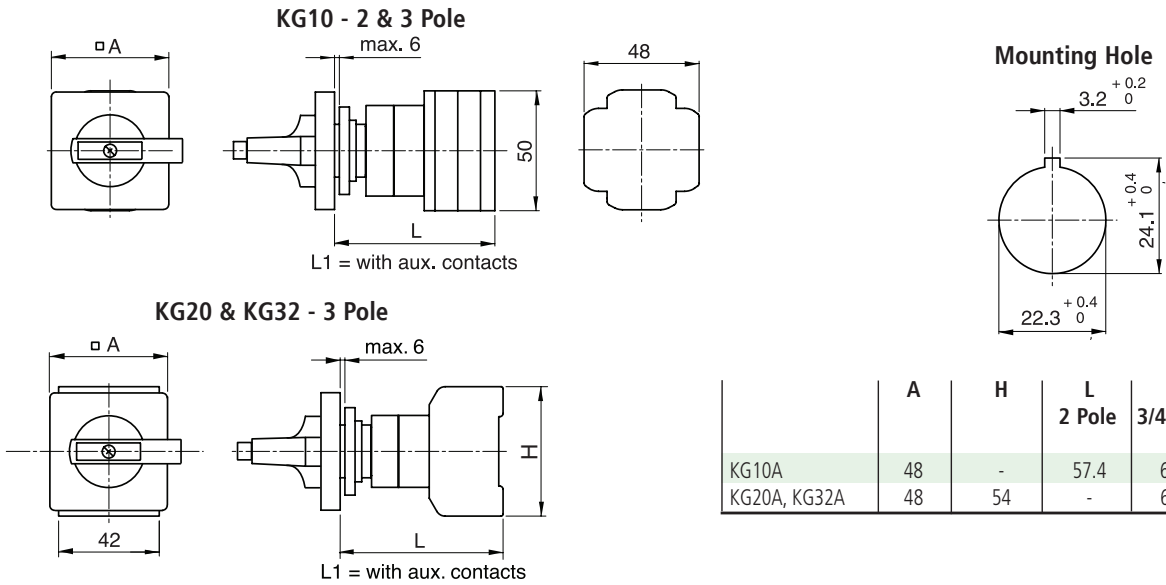

### Front Panel Mounting - 4 Hole Fixing

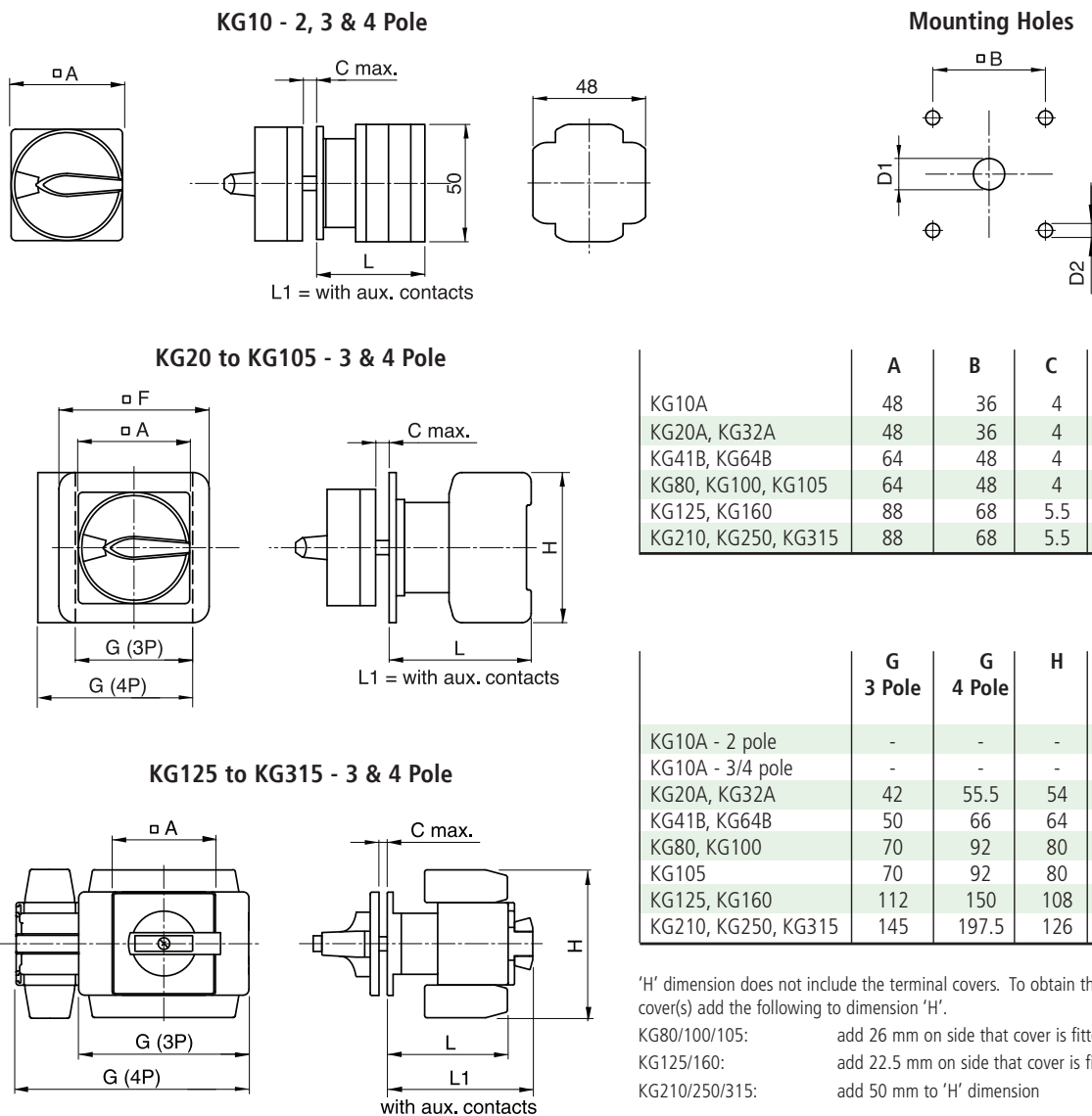

'H' dimension does not include the terminal covers. To obtain the dimension across the terminal cover(s) add the following to dimension 'H'.

KG80/100/105: add 26 mm on side that cover is fitted.

KG125/160: add 22.5 mm on side that cover is fitted

KG210/250/315: add 50 mm to 'H' dimension

Factory fitted auxiliary contacts are integral with the main switch body – they are not side mounting type.

# KG Main / Emergency-Off Switches

## Base Mounting with Door Interlock

### 3, 3 + N & 4 Pole - plan view

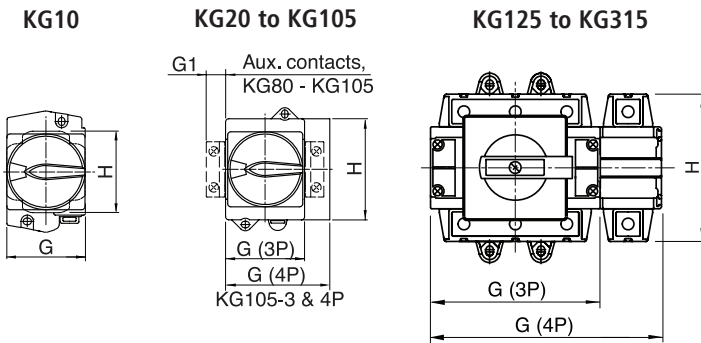

### 6 Pole - plan view

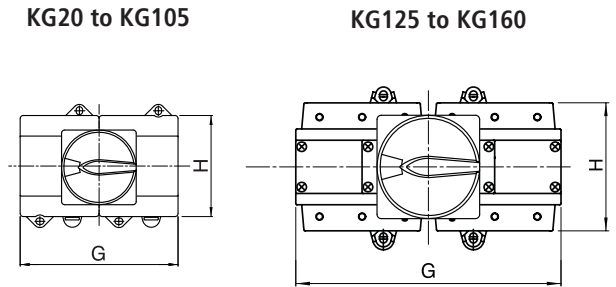

### Base Mounting Holes

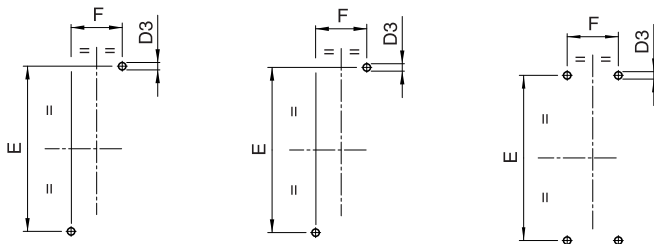

### Base Mounting Holes

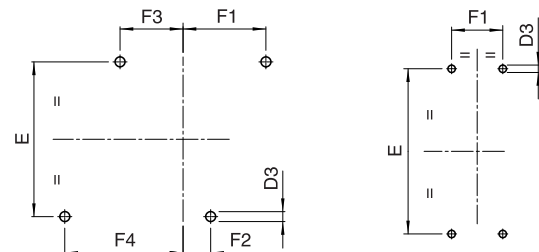

	D3	E	F	F1	F2	F3	F4	G 3 Pole	G 3 Pole+N	G 4 Pole	G 6 Pole	G1	H
KG10A & B	5	60	22	-	-	-	-	48	-	48	-	-	50
KG20A & B, KG32A & B	5	60	22	32	10	10	32	42	55.5	55.5	84	-	54
KG41B, KG64B	5	70	25	37.5	12.5	12.5	37.5	50	66	66	100	-	64
KG80, KG100	6	90	25	47.5	22.5	22.5	47.5	70	92	92	140	12.2	80
KG105	6	90	25	-	-	-	-	70	92	92	140	12.2	80
KG125, KG160	6.4	120	36	76	-	-	-	112	-	150	224	-	108
KG210, KG250, KG315	6.4	142	44	-	-	-	-	145	-	197.5	-	-	126

'H' dimension does not include the terminal covers. To obtain the dimension across the terminal cover(s) add the following to dimension 'H'.

KG80/100/105: add 26 mm on side that cover is fitted.

KG125/160: add 22.5 mm on side that cover is fitted

KG210/250/315: add 50 mm to 'H' dimension

Factory fitted auxiliary contacts are integral with the main switch body – they are not side mounting type.

Note: Handle styles vary - see relevant catalogue section for handle style used.

### Defeatable Door Interlock, Single Hole Fixing. 3 & 4 Pole Switches

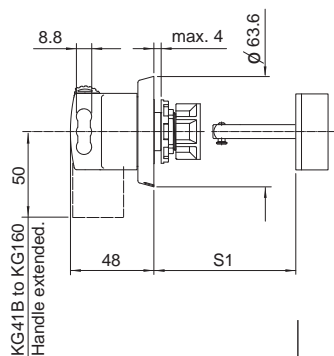

### Door Interlock, Single Hole Fixing. 3, 3+N, 4 & 6 Pole KG10 to KG105

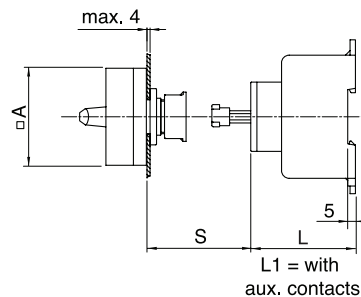

### Handle Mounting Hole

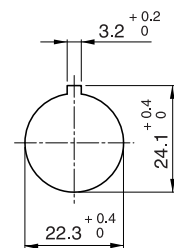

	A	L 3/4 Pole	L1 3/4 Pole	S	S1 3/4 pole	L 6 Pole	L1 6 Pole	S 6 Pole
KG10A	48	49.2	58.7	31-191	-	-	-	-
KG20A, KG32A	48	50	59	31-196	-	-	-	-
KG20B, KG32B	64	50	59	-	47-202mm	57.5	66.5	31-199
KG41B, KG64B	64	61	71	31-192	31-202mm	67	77	31-193
KG80, KG100, KG105	64	68	78	32-189	32-202mm	79.2	89.2	32-189
KG125, KG160	-	91	91	-	34-263mm	-	-	-

# KG Main / Emergency-Off Switches

## Base Mounting with Door Interlock, Continued

### Door Interlock, 4 Hole Fixing. 3, 4 & 6 Pole Switches - side view.

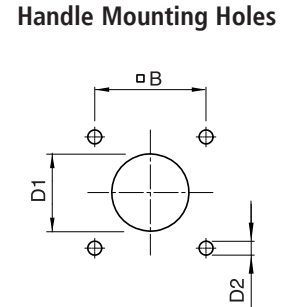
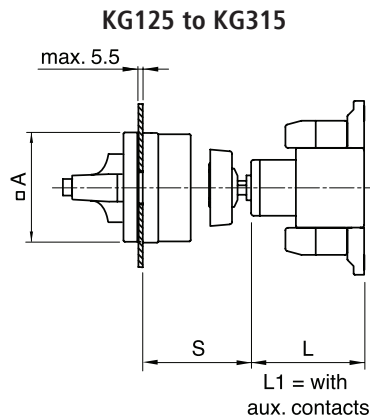
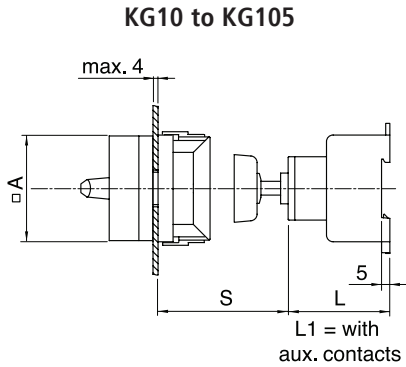

	Shaft Length	A	B	D1	D2	3/4 Pole & 3 Pole + N			6 Pole		
						L	L1	S	L	L1	S
KG10A	200	48	36	18-22	5	49.2	58.7	37-197	-	-	-
KG20A, KG32A	200	48	36	18-22	5	50	59	37-202	-	-	-
KG20B, KG32B	200	64	48	19-22	5	-	-	-	57.5	66.5	37-205
KG41B, KG64B	200	64	48	19-22	5	61	71	35-200	67	77	35-201
KG80, KG100, KG105	200	64	48	19-22	5	68	78	36-197	79.2	89.2	36-197
KG125, KG160	300	88	68	26-30	6	91	91	45-306	93	93	45-306
KG210, KG250, KG315	300	88	68	26-30	6	98	98	45-306	-	-	-

### Defeatable Door Interlock, 4 Hole Fixing. 3, 4 & 6 Pole Switches - side view.

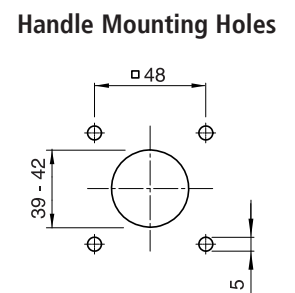
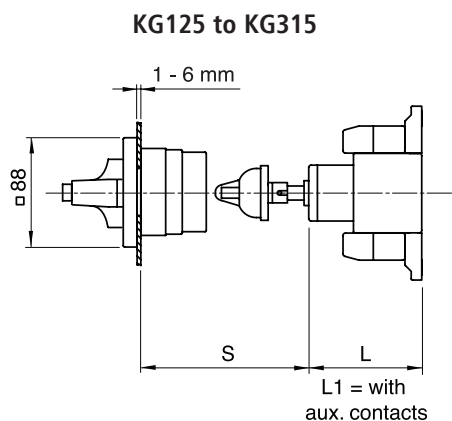
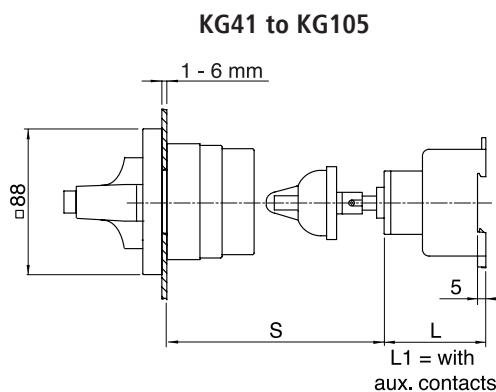

	L	L1	S	L	L1	S
	3/4 Pole	3/4 Pole	3/4 Pole	6 Pole	6 Pole	6 Pole
KG41B, KG64B	61	71	72-224	67	77	72-225
KG80, KG100, KG105	68	78	73-221	79.2	89.2	73-221
KG125, KG160	91	91	83-336	93	93	83-336
KG210, KG250, KG315	98	98	83-336	-	-	-



# KG Changeover Switches

## Base Mounting with Door Interlock, 4 Hole Fixing

### KG20 to KG105 - 3 & 4 Pole

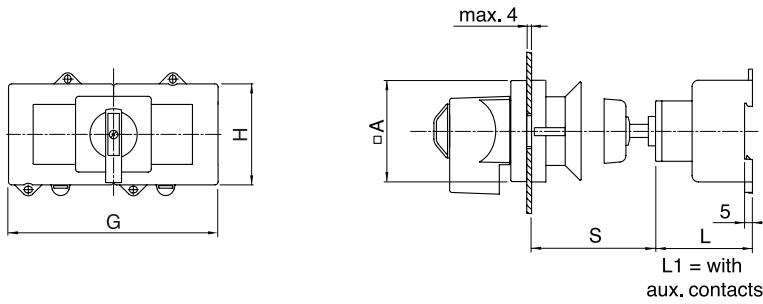

### Base Mounting Holes

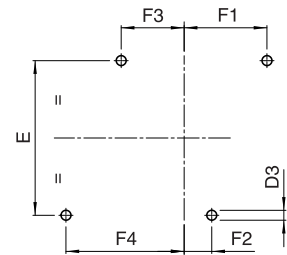

### KG125 to KG160 - 3 & 4 Pole

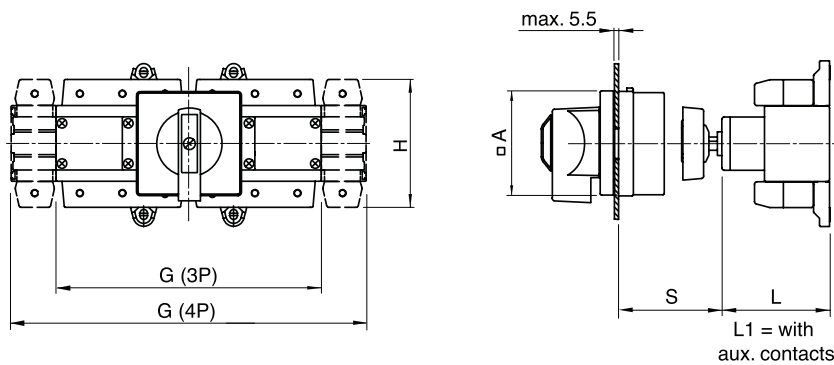

### Base Mounting Holes

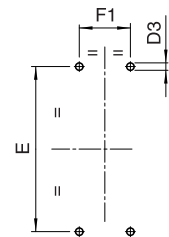

	A	B	D1	D2	D3	E	F1	F2	F3 3 Pole
KG20B, KG32B	64	48	19 - 22	5	5	60	32	10	10
KG41B, KG64B	64	48	19 - 22	5	5	70	37.5	12.5	12.5
KG80, KG100	88	48	19 - 22	5	6	90	47.5	22.5	22.5
KG105	88	48	19 - 22	5	6	90	47.5	22.5	-
KG125, KG160	88	68	26 - 30	6	6.4	120	76	-	-

### Handle Mounting Holes

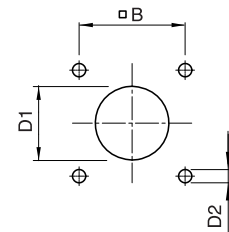

	F4 3 Pole	F3 4 Pole	F4 4 Pole	G 3 Pole	G 4 Pole	H	L	L1	S
KG20B, KG32B	32	23.5	45.5	84	111	54	57.5	66.5	37-125
KG41B, KG64B	37.5	28.5	53.5	100	132	64	67	77	35-131
KG80, KG100	47.5	44.5	69.5	140	184	80	79.2	89.2	36-127
KG105	-	44.5	69.5	140	184	80	79.2	89.2	36-127
KG125, KG160	-	-	-	224	300	108	93	93	45-196

Factory fitted auxiliary contacts are integral with the main switch body – they are not side mounting type.

## KG Changeover Switches

Base Mounting - For 45 mm Installation Cut - Out

KG41 to KG105 - 4 Pole

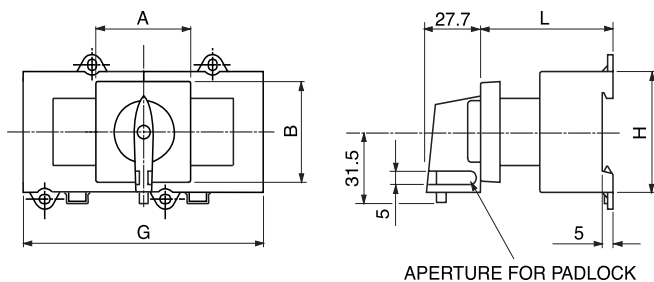

Mounting Holes

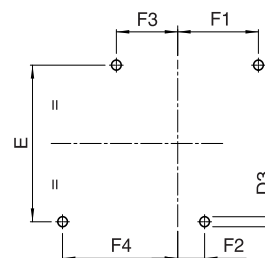

	A	B	D3	E	F1	F2	F3	F4	G	H	L
KG41B, KG64B	105.4	45.4	5	70	37.5	12.5	28.5	53.5	132	64	67.5
KG80, KG100, KG105	70	45	6	90	47.5	22.5	44.5	69.5	184	80	81.2

## KG Switch Options

Side Mounting Modules

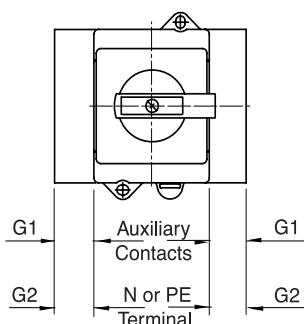

	G1	G2
KG20A & B, KG32A & B	10	13.5
KG41B, KG64B	11	16
KG80, KG100, KG105	11	22
KG125, KG160	14	38
KG210, KG250, KG315	14	52.5

**Note:**  
KG125 to KG315 4 pole switches cannot have additional modules fitted on the side adjacent to the 4th pole (switched neutral).

Terminal Covers

KG10 to KG105

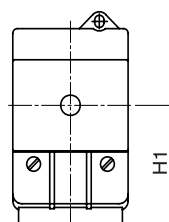

KG125 to KG315

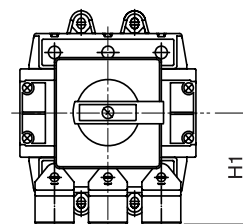

	H1
KG10A & B	32
KG20A & B, KG32A & B	47
KG41B, KG64B	49
KG80, KG100, KG105	66
KG125, KG160	76.2
KG210, KG250, KG315	88



# KH Changeover Switches

## Base Mounting With Door Interlock, 4 Hole Fixing

KH16 to KH85 - 2 Pole

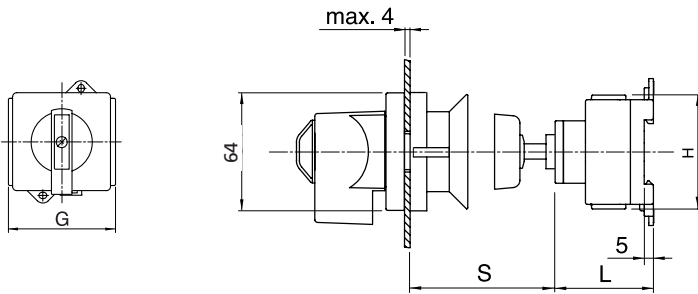

Mounting Holes

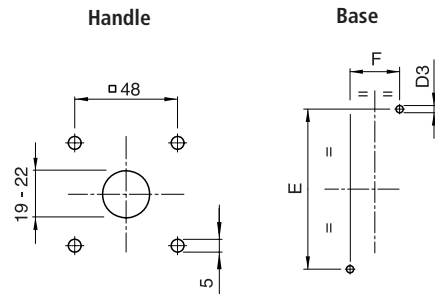

'H' dimension for KH63/80/85 does not include the terminal cover. To obtain the dimension across the terminal cover(s) add 23.5 mm on side that cover is fitted.

	D3	E	F	G	H	L	S
KH16, KH20, KH25	5	60	22	60	56	47	37-122
KH32, KH40	5	70	25	70	62	53.5	39-132
KH63, KH80, KH85	6	90	25	86	90	59.5	39-132

## Base Mounting - For 45 mm Installation Cut-Out

KH16 to KH85 - 2 Pole

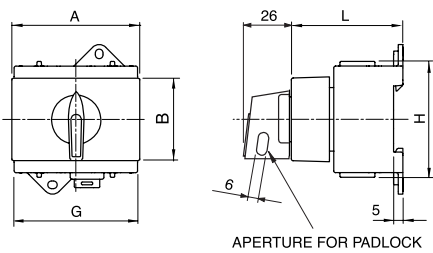

Mounting Holes

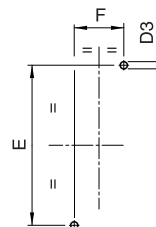

	A	B	D3	E
KH16, KH20, KH25	43.7	45.4	5	60
KH32, KH40	70.4	45.4	5	70
KH63, KH80, KH85	70.4	45.4	6	90

	F	G	H	L
KH16, KH20, KH25	22	60	56	58.5
KH32, KH40	25	70	62	59.7
KH63, KH80, KH85	25	86	90	66.7

# KH Switch Options

## Terminal Covers

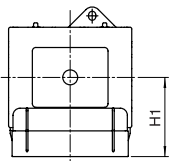

	H1
KH32, KH40	45
KH63, KH80, KH85	68.5

SWITCH DISCONNECTORS

ENCLOSED SWITCHES



## Short form catalogue

**Kraus & Naimer Ltd** 115 London Road Newbury Berkshire RG14 2AH  
sales-uk@krausnaimer.com Direct Sales Line 01635 262626

[krausnaimer.co.uk](http://krausnaimer.co.uk) SF04/2019