

Universal Relays

RU Series



Full featured universal miniature relays. Designed with environment taken into consideration.



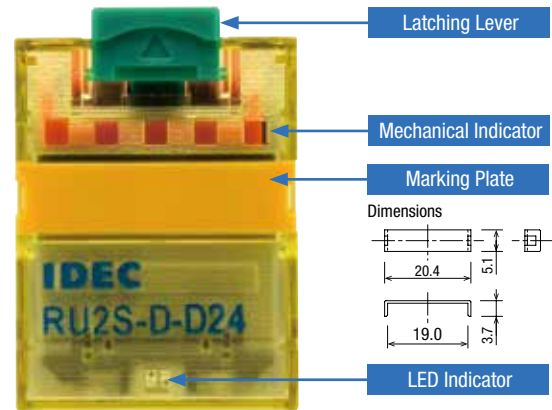
- See website for details on approvals and standards.
- Lloyd Register type approved.

Safety

The contact position can be confirmed through the five small windows.

Using the latching lever, operation can be checked without energizing the coil. The latching lever is color coded for AC and DC coils. (AC coil: Orange DC coil: Green)

Non-polarized LED indicator available on plug-in relays.



Environment

RoHS compliant models available. Complies with EU directive 2002/95/EC (Restricted substances: lead, Cadmium, Mercury, Hexavalent Chromium, PBB, PBDE)

Reliable

No internal wires. Simple construction.

Easy-to-Use

Marking plate for easy identification of relays

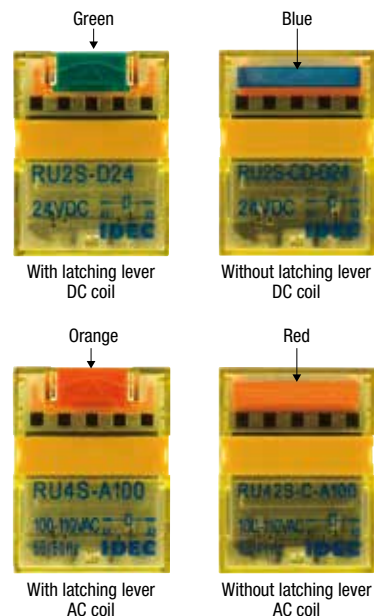
(Optional marking plates available in four other colors)

Applicable for small loads to maximum contact currents.

(See table below)



	RU2	RU4	RU42
Max. continuous current	10A	6A	3A
Min. applicable load (Note)	24V DC 5mA	1V DC 1mA	1V DC 0.1mA

Note: Reference value.




RU Series Universal Relays

Single Contact

shape			 Plug-in Terminal With Latching Lever Standard (DPDT)		 PCB Terminal Without Latching Lever Standard (4PDT)	
Termination	Latching Lever	Style	Part No.		Coil Voltage Code *	
			DPDT	4PDT		
Plug-in Terminal (*1)	With Latching Lever	Standard	RU2S-*	RU4S-*	A24, A100, A110, A200, A220 D6, D12, D24, D48, D100, D110	
		With RC (AC coil only)	RU2S-R-*	RU4S-R-*	A100, A110, A200, A220	
		With diode (DC coil only)	RU2S-D-*	RU4S-D-*	D6, D12, D24, D48, D110	
		With diode (DC coil only) Reverse polarity coil	RU2S-D1-*	RU4S-D1*	D24	
	Without Latching Lever	Standard	RU2S-C-*	RU4S-C-*	A24, A100, A110, A200, A220 D6, D12, D24, D48, D100, D110	
		With RC (AC coil only)	RU2S-CR-*	RU4S-CR-*	A100, A110, A200, A220	
		With diode (DC coil only)	RU2S-CD-*	RU4S-CD-*	D6, D12, D24, D48, D110	
		With diode (DC coil only) Reverse polarity coil	RU2S-CD1-*	RU4S-CD1-*	D24	
PCB Terminal	Without Latching Lever	Simple (*2)	RU2V-NF-*	RU4V-NF-*	A24, A100, A110, A200, A220 D6, D12, D24, D48, D100, D110	

Bifurcated Contact

shape			 Plug-in Terminal With Latching Lever Standard	
Termination	Latching Lever	Style	Part No. 4PDT	Coil Voltage Code *
Plug-in Terminal (*1)	With Latching Lever	Standard	RU42S-*	A24, A100, A110, A200, A220 D6, D12, D24, D48, D100, D110
		With RC (AC coil only)	RU42S-R-*	A100, A110, A200, A220
		With diode (DC coil only)	RU42S-D-*	D6, D12, D24, D48, D100, D110
		With diode (DC coil only) Reverse polarity coil	RU42S-D1-*	D24
	Without Latching Lever	Standard	RU42S-C-*	A24, A100, A110, A200, A220 D6, D12, D24, D48, D100, D110
		With RC (AC coil only)	RU42S-CR-*	A100, A110, A200, A220
		With diode (DC coil only)	RU42S-CD-*	D6, D12, D24, D48, D100, D110
		With diode (DC coil only) Reverse polarity coil	RU42S-CD1-*	D24
PCB Terminal	Without Latching Lever	Simple (*2)	RU42V-NF-*	A24, A100, A110, A200, A220 D6, D12, D24, D48, D100, D110

*1) Plug-in terminal, except for simple types, have an LED indicator and a mechanical indicator as standard.

*2) Simple types do not have an LED indicator, a mechanical indicator, and a latching lever.

Accessory

Name	Part No.	Ordering No.	Color Code *	Package Quantity
Marking Plate	RU9Z-P*	RU9Z-P*PN10	A (orange), G (green), S (blue), W (white), Y (yellow)	10

Note: Specify a color code in place of the Part No. When ordering, specify the Ordering No.
The marking plate can be removed from the relay by inserting a flat screwdriver under the marking plate.

Part No. Development

Specify a coil voltage code in place of * in the Part No.

Coil Voltage Code *	Coil Rating
24V AC	White
100-110V AC	Clear
110-120V AC	Blue
200-220V AC	Black
220-240V AC	Red
24V DC	Green
6V DC	Voltage marking on yellow tape
12V DC	
48V DC	
100V DC	
110V DC	

APEM

Switches & Pilot Lights

Control Boxes

Emergency Stop Switches

Enabling Switches

Safety Products

Explosion Proof

Terminal Blocks

Relays & Sockets

Circuit Protectors

Power Supplies

LED Illumination

Controllers

Operator Interfaces

Sensors

AUTO-ID

Relays

Sockets

DIN Rail Products

RJ

RU

RV8H

RL



Download catalogs and CAD from <http://eu.idec.com/downloads>

RU Series Universal Relays

Coil Ratings

Rated Voltage (V)	Coil Voltage Code	Rated Current (mA) ±15% (at 20°C)		Coil Resistance (Ω) ±10% (at 20°C)	Operating Characteristics (against rated values at 20°C)			
		50 Hz	60 Hz		Maximum Continuous Applied Voltage	Minimum Pickup Voltage	Dropout Voltage	
AC (50/60 Hz)	24	A24	49.3	42.5	110%	80% maximum	30% minimum	
	100-110	A100	9.2-11.0	7.8-9.0				164
	110-120	A110	8.4-10.0	7.1-8.2				3,460
	200-220	A200	4.6-5.5	4.0-4.6				4,550
	220-240	A220	4.2-5.0	3.6-4.2	14,080			
DC	6	D6	155		110%	80% maximum	10% minimum	
	12	D12	80					40
	24	D24	44.7					160
	48	D48	18					605
	100	D100	9.7					2,560
	110	D110	8.9					10,000
					12,100			

• The rated current includes the current draw by the LED indicator.

Contact Ratings

Contact	Continuous Current	Allowable Contact Power		Voltage (V)	Rated Load			
		Resistive Load	Inductive Load		Res. Load	Ind. Load	Electrical Life (operations)	
DPDT (RU2)	10A	2500VA AC 300W DC	1250VA AC 150W DC	250 AC	10A	5A	100,000 min.	
					5A	—	500,000 min.	
					—	2.5A	300,000 min.	
				30 DC	10A	5A	100,000 min.	
					5A	—	500,000 min.	
					—	2.5A	300,000 min.	
110 DC	0.6A	0.4A	100,000 min.					
	6A	2.6A	50,000 min.					
	3A	0.8A	200,000 min.					
4PDT (RU4)	6A	1500VA AC 180W DC	600VA AC 90W DC	250 AC	6A	2.7A	50,000 min.	
					3A	1.5A	200,000 min.	
				30 DC	0.65A	0.33A	50,000 min.	
					0.33A	0.18A	200,000 min.	
				110 DC	250 AC	3A	0.8A	100,000 min.
					30 DC	3A	1.5A	100,000 min.
110 DC	0.44A	0.22A	100,000 min.					

• On 4PDT relays, the maximum allowable total current of neighboring two poles is 6A. At the rated load, make sure that the total current of neighboring two poles does not exceed 6A (3A + 3A = 6A).

UL and c-UL Ratings

Voltage	Resistive			General Use			Horse Power Rating		
	RU2	RU4	RU42	RU2	RU4	RU42	RU2	RU4	RU42
250V AC	10A	—	—	—	6A	3A	—	1/10HP	—
30V DC	10A	6A	3A	—	—	—	—	—	—

CSA Ratings

Voltage	Resistive								
	RU2	RU4	RU42	RU2	RU4	RU42	RU2	RU4	RU42
250V AC	10A	—	—	—	6A	3A	—	1/10HP	—
30V DC	10A	6A	3A	—	—	—	—	—	—

TÜV Ratings

Voltage	Resistive			Inductive		
	RU2	RU4	RU42	RU2	RU4	RU42
250V AC	10A	6A	3A	5A	0.8A	0.8A
30V DC	10A	6A	3A	5A	1.5A	1.5A

Surge Suppressor Ratings

Type	Ratings	
AC Coil	With RC	RC series circuit R: 20 kΩ, C: 0.033 μF
DC Coil	With Diode	Diode reverse voltage: 1000V Diode forward current: 1A

Specifications

Model	RU2 (DPDT)	RU4 (4PDT)	RU42 (4PDT)
Contact Material	Silver alloy	Silver (gold clad)	Silver-nickel (gold clad)
Contact Resistance (*1)	50 mΩ maximum		
Minimum Applicable Load (*2)	24V DC, 5 mA	1V DC, 1 mA	1V DC, 0.1 mA
Operate Time (*3)	20 ms maximum		
Release Time (*3)	20 ms maximum		
Power Consumption	AC: 1.1 to 1.4VA (50 Hz), 0.9 to 1.2VA (60 Hz) DC: 0.9 to 1.0W		
Insulation Resistance	100 MΩ minimum (500V DC megger)		
Dielectric Strength	Between contact and coil: 2500V AC, 1 minute		
	Between contacts of different poles: 2500V AC, 1 minute		
	Between contacts of the same pole: 1000V AC, 1 minute		
Operating Frequency	Electrical: 1800 operations/h maximum Mechanical: 18,000 operations/h maximum		
Vibration Resistance	Damage limits: 10 to 55 Hz, amplitude 0.5 mm Operating extremes: 10 to 55 Hz, amplitude 0.5 mm		
Shock Resistance	Damage limits: 1000 m/s ² Operating extremes: 150 m/s ²		
Mechanical Life	AC: 50,000,000 operations DC: 100,000,000 operations		50,000,000 operations
Electrical Life	See H-019 and H-021 .		
Operating Temperature (*4)	PCB terminal: -55 to +70°C (no freezing) Others: -55 to +60°C (no freezing)		
Operating Humidity	5 to 85% RH (no condensation)		
Storage Temperature	-55 to +70°C RH (no freezing)		
Storage Humidity	5 to 85% RH (no condensation)		
Weight (Approx.)	35g		

Note: Above values are initial values.

*1) Measured using 5V DC, 1A voltage drop method

*2) Measured at operating frequency of 120 operations/min (failure rate level P, reference value)

*3) Measured at the rated voltage (at 20°C), excluding contact bouncing;
Release time of AC relays with RC: 25 ms maximum
Release time of DC relays with diode: 40 ms maximum

*4) Measured at the rated voltage.

RU2 (DPDT Contact)

Dimensions

Plug-in Terminal



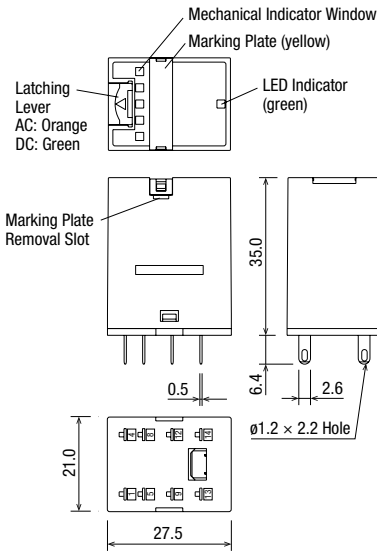
Photo: RU2S-A100

PCB Terminal

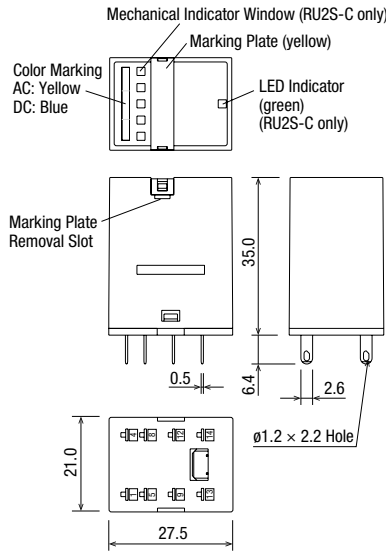


Photo: RU2V-NF-A100

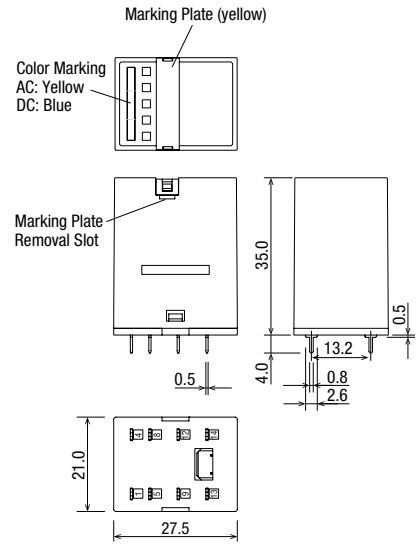
RU2S



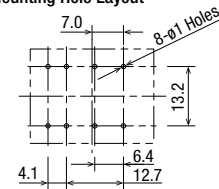
RU2S-C/RU2S-NF



RU2V



Mounting Hole Layout

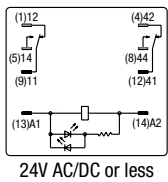


Marking plate removal slot is provided only on one side. Insert a flat screwdriver into the slot to remove the marking plate.

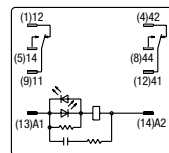
All dimensions in mm.

Internal Connection (Bottom View)

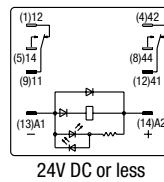
RU2S-* Standard



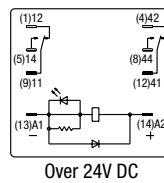
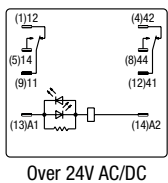
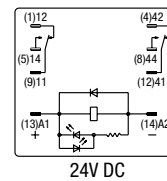
RU2S-*R With RC



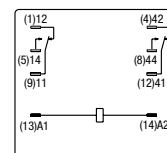
RU2S-*D With Diode



RU2S-*D1 With Diode Reverse Polarity Coil



RU2S-NF-*/RU2V-NF-*



Blank or C comes in place of * to represent types with or without a latching lever.

- APEM
- Switches & Pilot Lights
- Control Boxes
- Emergency Stop Switches
- Enabling Switches
- Safety Products
- Explosion Proof
- Terminal Blocks
- Relays & Sockets
- Circuit Protectors
- Power Supplies
- LED Illumination
- Controllers
- Operator Interfaces
- Sensors
- AUTO-ID

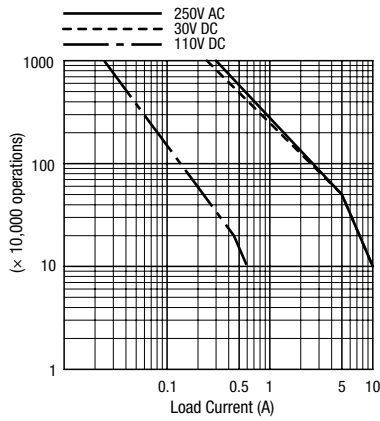
- Relays
- Sockets
- DIN Rail Products
- RU
- RU
- RV8H
- RL



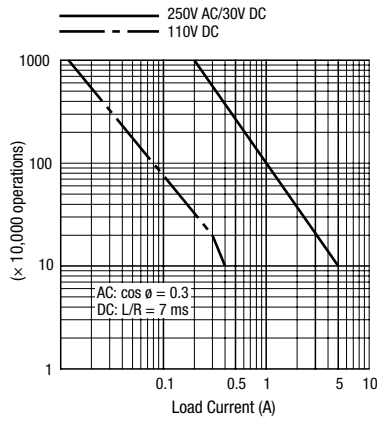
RU Series Universal Relays

Electrical Life Curves

RU2 (Resistive Load)

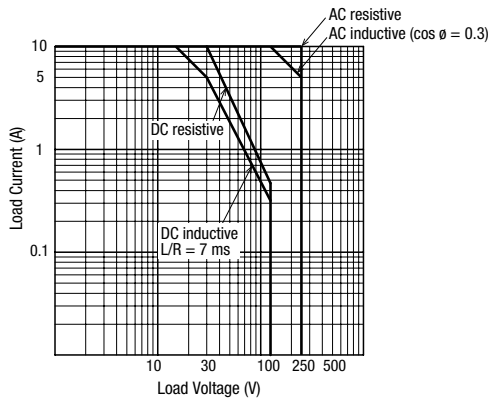


RU2 (Inductive Load)



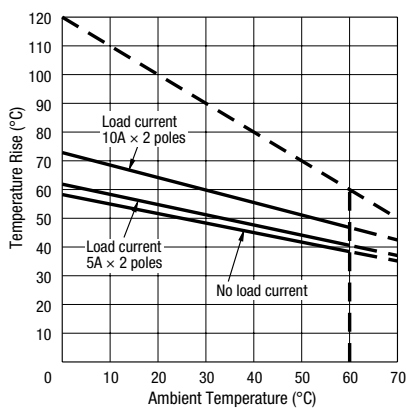
Maximum Switching Current

RU2

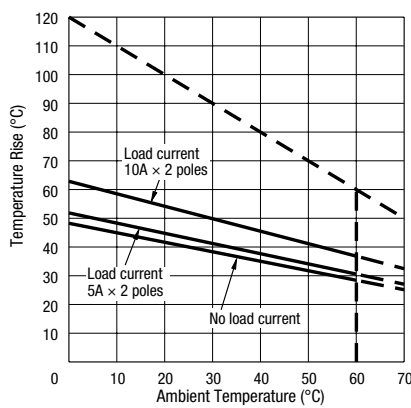


Ambient Temperature vs. Temperature Rise Curves

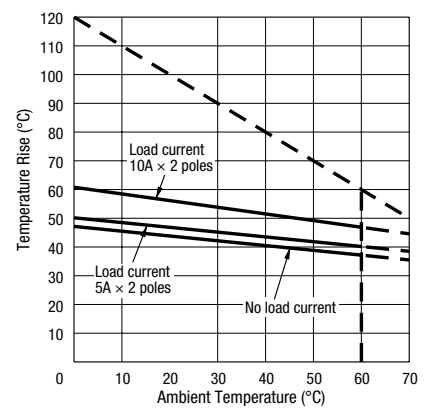
RU2 (AC Coil, 50 Hz)



RU2 (AC Coil, 60 Hz)



RU2 (DC Coil)



The above temperature rise curves show the characteristics when 100% the rated coil voltage is applied. The heat resistance of the coil is 120°C. The slant dashed line indicates the allowable temperature rise for the coil at different ambient temperatures.

RU4 (4PDT Contact)

Dimensions

Plug-in Terminal



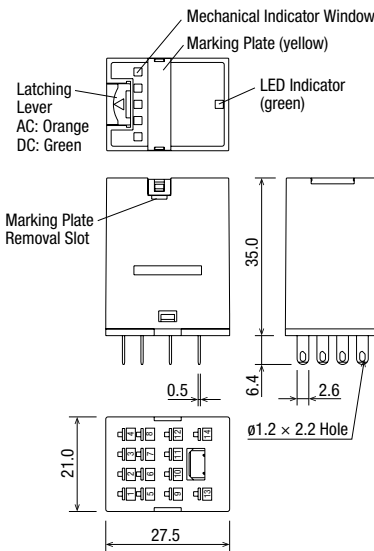
Photo: RU42S-A100

PCB Terminal

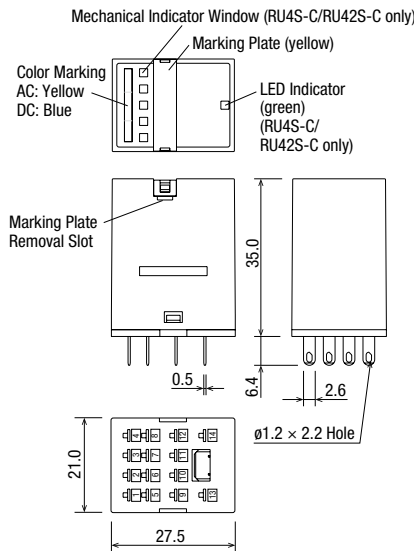


Photo: RU4V-NF-D24

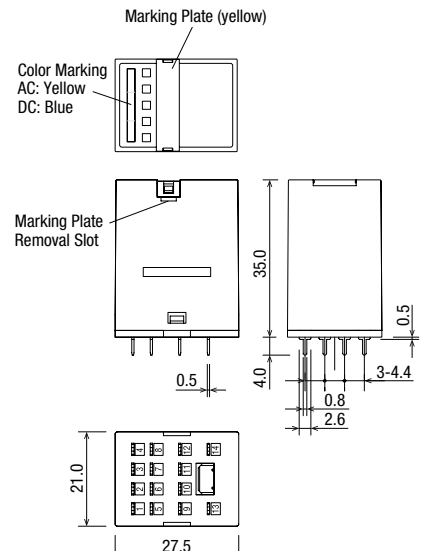
RU4S/RU42S



RU4S-C/RU4S-NF
RU42S-C/RU42S-NF



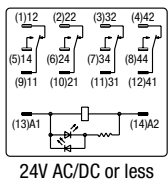
RU4V/RU42V



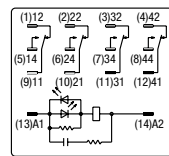
Marking plate removal slot is provided only on one side. Insert a flat screwdriver into the slot to remove the marking plate.

Internal Connection (Bottom View)

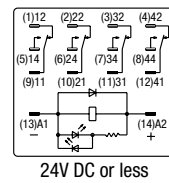
RU4S-*/RU42S-*



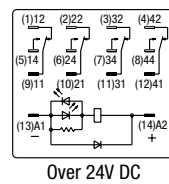
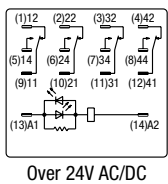
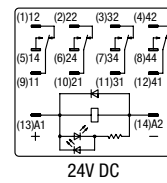
RU4S-*R/RU42S-*R



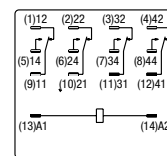
RU4S-*D/RU42S-*D



RU4S-*D1/RU42S-*D1



RU4S-NF-*/RU4V-NF-*



Blank or C comes in place of * to represent types with or without a latching lever.

All dimensions in mm.



Download catalogs and CAD from <http://eu.idec.com/downloads>

- APEM
- Switches & Pilot Lights
- Control Boxes
- Emergency Stop Switches
- Enabling Switches
- Safety Products
- Explosion Proof
- Terminal Blocks
- Relays & Sockets
- Circuit Protectors
- Power Supplies
- LED Illumination
- Controllers
- Operator Interfaces
- Sensors
- AUTO-ID

Relays

- Sockets
- DIN Rail Products

RJ

RU

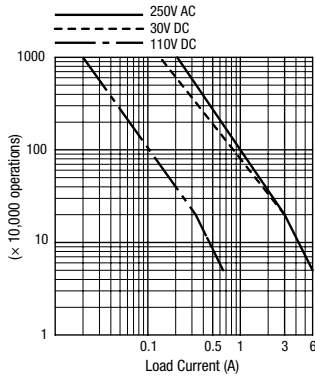
RV8H

RL

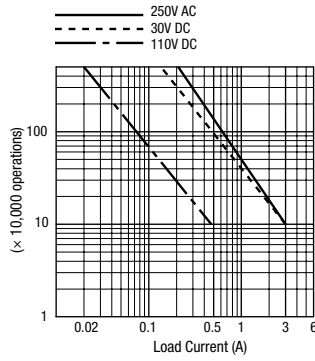
RU Series Universal Relays

Electrical Life Curves

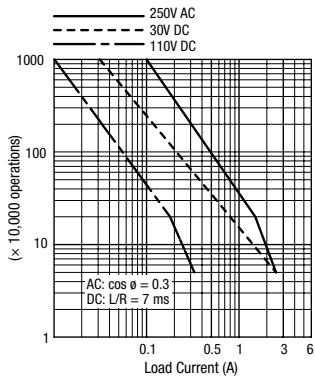
RU4 (Resistive Load)



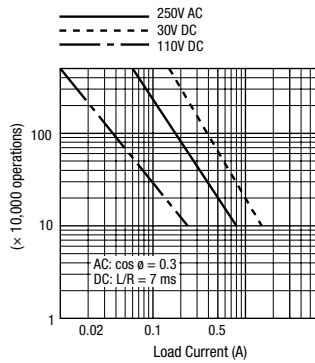
RU42 (Resistive Load)



RU4 (Inductive Load)

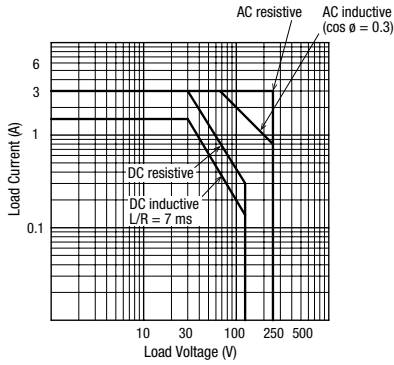


RU42 (Inductive Load)

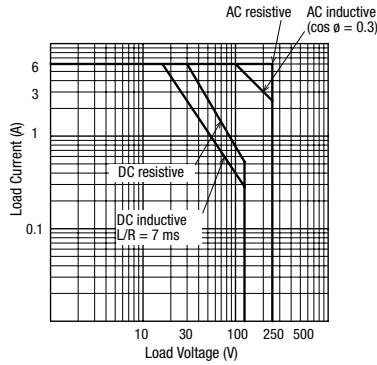


Maximum Switching Current

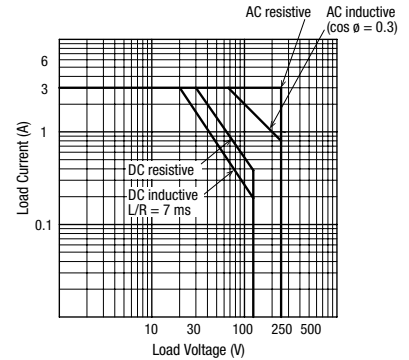
RU4 (Rated Load)



RU4 (Maximum Load)

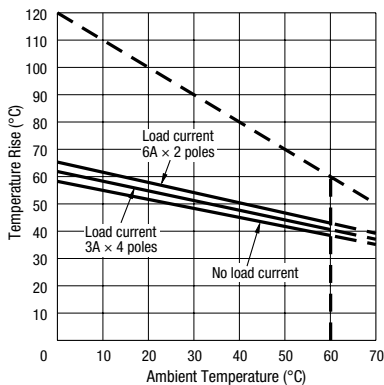


RU42

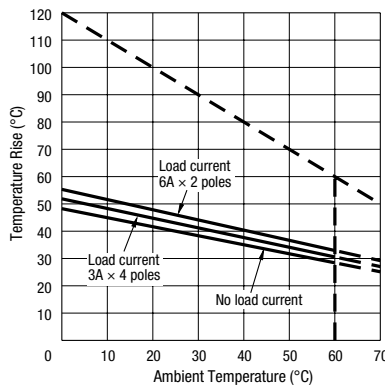


Ambient Temperature vs. Temperature Rise Curves

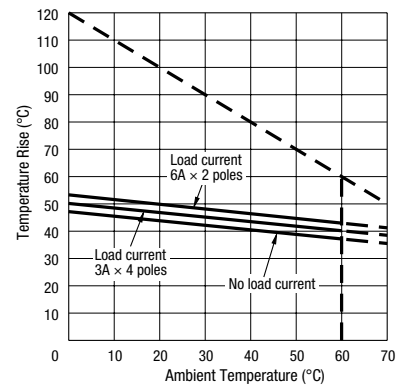
RU4/RU42 (AC Coil, 50 Hz)



RU4/RU42 (AC Coil, 60 Hz)





































RU4/RU42 (DC Coil)



The above temperature rise curves show the characteristics when 100% the rated coil voltage is applied. Load current 6A x 2 poles is for the RU4 only.

The heat resistance of the coil is 120°C. The slant dashed line indicates the allowable temperature rise for the coil at different ambient temperatures.

Applicable Socket

Relay	Wiring Style	Shape	Part No.	Rated Current	Style	Applicable Spring	
						Hold-down Spring	Wire Spring
RU2	Front Wiring Socket		SM2S-05B	7A	Standard 	SFA-202 SFA-101	—
			SM2S-05C (*1)	7A (UL: 10A)	Finger-safe 		
			SM2S-05D	10A	Slim 	SFA-503	
			SM2S-05DF (*1)	10A	Finger-safe 		
			SU2S-11L	10A 8A (collective mounting) (*3)	Spring clamp (*2) 	SFA-202 SFA-101	
	Rear Wiring Socket		SM2S-51	10A	Solder 	SFA-301 SFA-302	SY4S-51F1
			SM2S-61	10A	PC board 		
			SM2S-62	10A	PC board 	SFA-504	
	RU4 RU42	Front Wiring Socket		SY4S-05B	7A	Standard 	SFA-202 SFA-101
			SY4S-05C (*1)	7A	Finger-safe 		
			SY4S-05D	6A	Slim 	SFA-502	
			SY4S-05DN	6A	Standard 	SFA-502	
			SY4S-05DF (*1)	6A	Finger-safe 	SFA-502	
			SU4S-11L	6A (4-pole) 10A (2-pole) 8A (2-pole, collective mounting) (*3)	Spring clamp (*2) 	SFA-202 SFA-101	
Rear Wiring Socket			SY4S-51	7A	Solder 	SFA-301 SFA-302	SY4S-51F1
			SY4S-61	7A	PC board 		
			SY4S-62	7A	PC board 	SFA-504	

*1) Finger-safe cannot be used with ring terminal.

*2) SU2S-11L and SU4S-11L are spring-clamp socket which does not require tightening screws. Stranded wire, solid wire, and ferrule can be attached using a screwdriver.

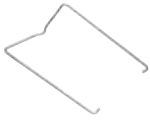



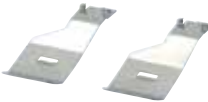



*3) When using SU2S-11L and SU4S-11L at rated current 8A and above, maintain at least 10mm distance from the adjacent SU socket.

*4) Front wiring socket can be mounted directly on DIN rail and mounting panel (some sockets need spacers for the ends).



RU Series Universal Relays

Hold-down Springs

Style	Shape	Material	Part No.	Ordering No.	Package Quantity
Wire Spring		Stainless Steel	SY4S-51F1	SY4S-51F1PN10	10
Leaf Spring			SFA-101	SFA-101PN20	10 pairs
			SFA-202	SFA-202PN20	
			SFA-301	SFA-301PN20	
			SFA-302	SFA-302PN20	
			SFA-502	SFA-502PN20	
			SFA-503	SFA-503PN20	
			SFA-504	SFA-504PN10	

- A relay needs a pair of leaf springs, except for SFA-504 (one spring per relay).
- When the wire spring SY4S-51F1 or leaf spring SFA-504 is used on a relay with latching lever, lever cannot be opened or closed.
- Leaf springs (except for the leaf spring SFA-504) cannot be removed after being installed on a socket (except for SM2S-05D and SY4S-05D)






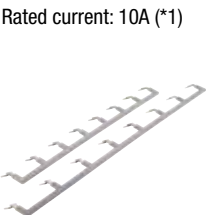
RJ

RU

RV8H

RL

Accessories for Sockets

Name	Shape	Specifications	Part No.	Ordering No.	Package Quantity	Remarks
DIN Rail		Aluminum Weight: Approx. 200g	BAA1000	BAA1000PN10	10	Length: 1m Width: 35 mm
		Steel Weight: Approx. 320g	BAP1000	BAP1000PN10	10	
End Clip		Zinc-plated steel Weight: Approx. 15g	BNL5	BNL5PN10	10	Used on a DIN rail to fasten relay sockets
			BNL6	BNL6PN10	10	
DIN Rail Spacer		Plastic (black)	SA-406B	SA-406B	1	Thickness: 5 mm Used for adjusting spacing between sockets mounted on a DIN rail
End Spacer		Plastic (black)	SA-203B	SA-203B	1	Used for mounting DIN rail mount sockets directly on a panel surface
			SA-204B	SA-204B	1	
Jumper		Rated current: 3A (*1) Brass jumper with ABS sheath Rated current: 3A Weight: Approx. 3g	SU9Z-J5	SU9Z-J5PN10	10	Used for interconnecting relay coil terminals on a maximum of five SU sockets; can be cut to required lengths
Jumper (for 2-pole socket)		Rated current: 10A (*1) Brass (Nickel-plated) with polyprene sheath	SM9Z-JF2	SM9Z-JF2PN10	10	Used for interconnecting relay coil terminals on SM2S-05DF sockets; can be cut to required length. No. of sockets: SM9Z-JF2: 2 SM9Z-JF5: 5 SM9Z-JF8: 8
			SM9Z-JF5	SM9Z-JF5PN10		
			SM9Z-JF8	SM9Z-JF8PN10		
Jumper (for 4-pole socket)			SY9Z-JF2	SY9Z-JF2PN10		
			SY9Z-JF5	SY9Z-JF5PN10		
			SY9Z-JF8	SY9Z-JF8PN10		

*1) Ensure that the total current to the jumper does not exceed the rated current.

APEM

Switches & Pilot Lights

Control Boxes

Emergency Stop Switches

Enabling Switches

Safety Products

Explosion Proof

Terminal Blocks

Relays & Sockets

Circuit Protectors

Power Supplies

LED Illumination

Controllers

Operator Interfaces

Sensors

AUTO-ID

Relays

Sockets

DIN Rail Products

RJ

RU

RV8H

RL



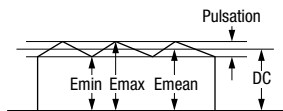
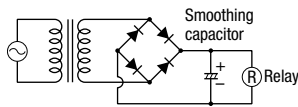
⚠ Safety Precautions

- Turn off the power to the relay before starting installation, removal, wiring, maintenance, and inspection of the relays. Failure to turn power off may cause electrical shock or fire hazard.
- Observe specifications and rated values, otherwise electrical shock or fire hazard may be caused.
- Use wires of the proper size to meet the voltage and current requirements. Tighten the terminal screws on the relay socket to the proper tightening torque.
- Before operating the latching lever, turn off the power to the RU relay. After checking the circuit, return the latching lever to the original position.
- Do not use the latching lever as a switch.
- The durability of the latching lever is a minimum of 100 operations.
- When using DC loads on 4PDT relays, apply a positive voltage to terminals of neighboring poles and a negative voltage to the other terminals of neighboring poles to prevent the possibility of short circuits.
- DC relays with a diode have a polarity in the coil terminals.
- The surge absorbing element on AC relays with RC or DC relays with diode is provided to absorb the counter electromotive force generated by the coil. When the relay is subject to an excessive external surge voltage, the surge absorbing element may be damaged. Add another surge absorbing provision to the relay to prevent damage.

Instructions

Driving Circuit for Relays

1. To make sure of correct relay operation, apply rated voltage to the relay coil.
2. Input voltage for the DC coil:
A complete DC voltage is best for the coil power to make sure of stable relay operation. When using a power supply containing a ripple voltage, suppress the ripple factor within 5%. When power is supplied through a rectification circuit, the relay operating characteristics, such as pickup voltage and dropout voltage, depend on the ripple factor. Connect a smoothing capacitor for better operating characteristics as shown below.



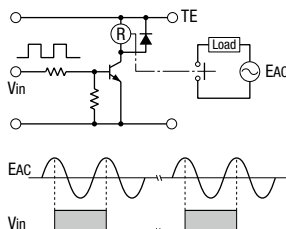
$$\text{Ripple factor (\%)} = \frac{E_{\max} - E_{\min}}{E_{\text{mean}}} \times 100\%$$

E_{\max} = Maximum of pulsating current

E_{\min} = Minimum of pulsating current

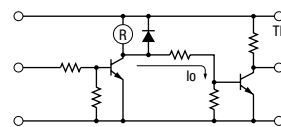
E_{mean} = DC mean value

3. Operating the relay in synchronism with AC load:
If the relay operates in synchronism with the AC power voltage of the load, the relay life may be reduced. If this is the case, select a relay in consideration of the required reliability for the load. Or, make the relay turn on and off irrespective of the AC power phase or near the point where the AC phase crosses zero voltage.

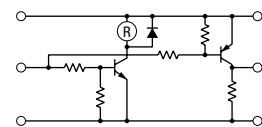


4. Leakage current while relay is off:
When driving an element at the same time as the relay operation, a special consideration is needed for the circuit design. As shown in the incorrect circuit below, Leakage current (I_0) flows through the relay coil while the relay is off. Leakage current causes the coil release failure or adversely affects the vibration resistance and shock resistance. Design a circuit as shown in the correct example.

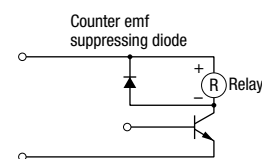
Incorrect



Correct



5. Surge suppression for transistor driving circuits:
When the relay coil is turned off, a high-voltage pulse is generated, causing the transistor to deteriorate and sometimes to break. Be sure to connect a diode to suppress the counter electromotive force. Then, the coil release time becomes slightly longer. To shorten the coil release time, connect a Zener diode between the collector and emitter of the transistor. Select a Zener diode with a Zener voltage slightly higher than the power voltage.



- APEM
- Switches & Pilot Lights
- Control Boxes
- Emergency Stop Switches
- Enabling Switches
- Safety Products
- Explosion Proof
- Terminal Blocks
- Relays & Sockets
- Circuit Protectors
- Power Supplies
- LED Illumination
- Controllers
- Operator Interfaces
- Sensors
- AUTO-ID

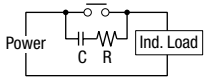
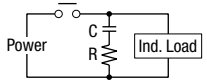
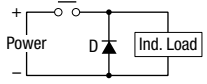
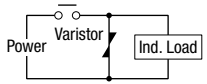
- Relays
- Sockets
- DIN Rail Products

- RJ
- RU
- RV8H
- RL

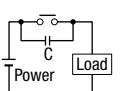
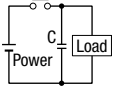
Instructions

Protection for Relay Contacts

- The contact ratings show maximum values. Make sure that these values are not exceeded. When an inrush current flows through the load, the contact may become welded. If this is the case, connect a contact protection circuit, such as a current limiting resistor.
- Contact protection circuit:
When switching an inductive load, arcing causes carbides to form on the contacts, resulting in an increased contact resistance. In consideration of contact reliability, contact life, and noise suppression, use of a surge absorbing circuit is recommended. Note that the release time of the load becomes slightly longer. Check the operation using the actual load. Incorrect use of a contact protection circuit will adversely affect switching characteristics. Four typical examples of contact protection circuits are shown in the following table:

RC		This protection circuit can be used when the load impedance is smaller than the RC impedance in an AC load power circuit. R: Resistor of approximately the same resistance value as the load C: 0.1 to 1 μF
		This protection circuit can be used for both AC and DC load power circuits. R: Resistor of approximately the same resistance value as the load C: 0.1 to 1 μF
Diode		This protection circuit can be used for DC load power circuits. Use a diode with the following ratings. Reverse withstand voltage: Power voltage of the load circuit × 10 Forward current: More than the load current
Varistor		This protection circuit can be used for both AC and DC load power circuits. For a best result, when using on a power voltage of 24 to 48V AC/DC, connect a varistor across the load. When using on a power voltage of 100 to 240V AC/DC, connect a varistor across the contacts.

- Do not use a contact protection circuit as shown below:

	This protection circuit is very effective in arc suppression when opening the contacts. But, the capacitor is charged while the contacts are opened. When the contacts are closed, the capacitor is discharged through the contacts, increasing the possibility of contact welding.
	This protection circuit is very effective in arc suppression when opening the contacts. But, when the contacts are closed, a current flows to charge the capacitor, causing contact welding.

Generally, switching a DC inductive load is more difficult than switching a DC resistive load. Using an appropriate arc suppressor, however, will improve the switching characteristics of a DC inductive load.

Other Precautions

- General notice:
To maintain the initial characteristics, do not drop the relay or shock the relay.
The relay cover cannot be removed from the base during normal operation. To maintain the initial characteristics, do not remove the relay cover.
Use the relay in environments free from condensation of dust, sulfur dioxide (SO₂), and hydrogen sulfide (H₂S).
Make sure that the coil voltage does not exceed the applicable coil voltage range.
- Connecting outputs to electronic circuits:
When the output is connected to a load which responds very quickly, such as an electronic circuit, contact bouncing causes incorrect operation of the load. Take the following measures into consideration.
Connect an integral circuit.
Suppress the pulse voltage due to bouncing within the noise margin of the load.
- UL- and CSA-approved ratings may differ from product rated values determined by IDEC.
- Do not use relays in the vicinity of strong magnetic field as this may affect relay operation.
DC diode type has polarity.
The surge absorbing element on AC relays with RC or DC relays with diode is provided to absorb the counter electromotive force generated by the coil. When the relay is subject to an excessive external surge voltage, the surge absorbing element may be damaged. Add another surge absorbing provision to the relay to prevent damage.

