



## Main

|                               |                                      |
|-------------------------------|--------------------------------------|
| Range of product              | Harmony XB5                          |
| Product or component type     | Head for non-illuminated push-button |
| Device short name             | ZB5                                  |
| Bezel material                | Dark grey plastic                    |
| Mounting diameter             | 22 mm                                |
| Head type                     | Standard                             |
| Sale per indivisible quantity | 1                                    |
| Shape of signaling unit head  | Round                                |
| Type of operator              | spring return                        |
| Operator profile              | Green flush, unmarked                |

## Complementary

|                             |  |
|-----------------------------|--|
| CAD overall width           | 29 mm  |
| CAD overall height          | 29 mm  |
| CAD overall depth           | 28 mm  |
| Net weight                  | 0.018 kg   |
| Mechanical durability       | 10000000 cycles  |
| Station name                | XALD 1...5 cut-outs<br>XALK 2...5 cut-outs   |
| Electrical composition code | C1 for <9 contacts using single blocks in front mounting<br>C2 for <9 contacts using single and double blocks in front mounting<br>C11 for <3 contacts using single blocks in front mounting<br>C15 for <1 contacts using single blocks in front mounting<br>SF1 for <3 contacts using single blocks in front mounting<br>SR1 for <3 contacts using single blocks in rear mounting |
| Device presentation         | Basic element  |

## Environment

|                      |    |
|----------------------|----|
| Protective treatment | TH |
|----------------------|----|

|                                       |  |
|---------------------------------------|--|
| Ambient air temperature for storage   | -40...70 °C  |
| Ambient air temperature for operation | -40...70 °C  |
| Overvoltage category                  | Class II conforming to IEC 60536   |
| IP degree of protection               | IP66 conforming to IEC 60529<br>IP67<br>IP69<br>IP69K  |
| NEMA degree of protection             | NEMA 13<br>NEMA 4X   |
| Resistance to high pressure washer    | 7000000 Pa at 55 °C, distance : 0.1 m  |
| IK degree of protection               | IK03 conforming to IEC 50102   |
| Standards                             | UL 508<br>EN/IEC 60947-1<br>EN/IEC 60947-5-1<br>CSA C22.2 No 14<br>EN/IEC 60947-5-4<br>JIS C8201-5-1<br>JIS C8201-1  |
| Product certifications                | UL listed<br>LROS (Lloyds register of shipping)<br>DNV<br>BV<br>RINA<br>GL<br>CSA  |
| Shock resistance                      | 30 gn (duration = 18 ms) for half sine wave acceleration conforming to IEC 60068-2-27<br>50 gn (duration = 11 ms) for half sine wave acceleration conforming to IEC 60068-2-27 |
| Vibration resistance                  | 5 gn (f= 2...500 Hz) conforming to IEC 60068-2-6   |

## Offer Sustainability

|                            |   |
|----------------------------|---|
| Sustainable offer status   | Green Premium product   |
| REACH Regulation           | <a href="#">REACH Declaration</a>   |
| REACH free of SVHC         | Yes   |
| EU RoHS Directive          | Pro-active compliance (Product out of EU RoHS legal scope)<br><a href="#">EU RoHS Declaration</a> |
| Toxic heavy metal free     | Yes   |
| Mercury free               | Yes   |
| RoHS exemption information | <a href="#">Yes</a>   |
| China RoHS Regulation      | <a href="#">China RoHS declaration</a>  |
| Environmental Disclosure   | <a href="#">Product Environmental Profile</a>   |
| Circularity Profile        | <a href="#">End of Life Information</a>   |

## Contractual warranty

|          |           |
|----------|-----------|
| Warranty | 18 months |
|----------|-----------|

---

Dimensions

---

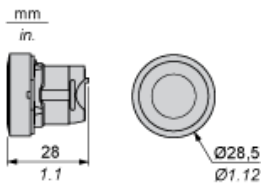

Panel Cut-out for Pushbuttons, Switches and Pilot Lights (Finished Holes, Ready for Installation)

Connection by Screw Clamp Terminals or Plug-in Connectors or on Printed Circuit Board

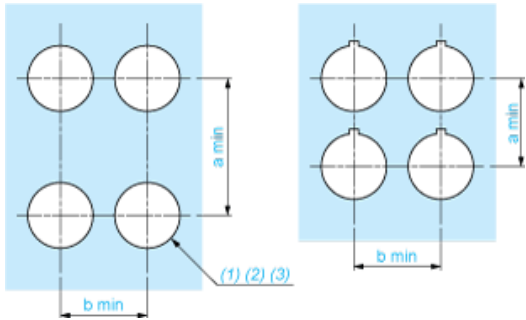

- (1) Diameter on finished panel or support
- (2) For selector switches and Emergency stop buttons, use of an anti-rotation plate type ZB5AZ902 is recommended.
- (3)  $\varnothing 22.5$  mm recommended ( $\varnothing 22.3 \text{ }_0^{+0.4}$ ) /  $\varnothing 0.89$  in. recommended ( $\varnothing 0.88 \text{ in. }_0^{+0.016}$ )

| Connections                                   | a in mm | a in in. | b in mm | b in in. |
|---|---------|----------|---------|----------|
| By screw clamp terminals or plug-in connector | 40      | 1.57     | 30      | 1.18     |
| By Faston connectors                          | 45      | 1.77     | 32      | 1.26     |
| On printed circuit board                      | 30      | 1.18     | 30      | 1.18     |

Detail of Lug Recess



- (1) Diameter on finished panel or support
- (2) For selector switches and Emergency stop buttons, use of an anti-rotation plate type ZB5AZ902 is recommended.
- (3)  $\varnothing 22.5$  mm recommended ( $\varnothing 22.3 \text{ }_0^{+0.4}$ ) /  $\varnothing 0.89$  in. recommended ( $\varnothing 0.88 \text{ in. }_0^{+0.016}$ )



Dimensions in in.

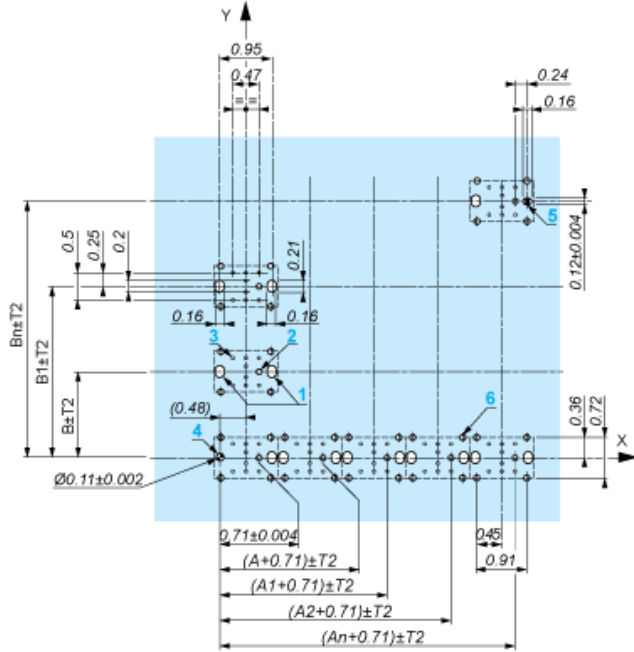

A: 1.18 in. min.  
B: 1.57 in. min.

### General Tolerances of the Panel and Printed Circuit Board

The cumulative tolerance must not exceed 0.3 mm / 0.012 in.:  $T1 + T2 = 0.3 \text{ mm max.}$

### Installation Precautions

- Minimum thickness of circuit board: 1.6 mm / 0.06 in.
- Cut-out diameter: 22.4 mm  $\pm$  0.1 / 0.88 in.  $\pm$  0.004
- Orientation of body/fixing collar ZB5AZ009:  $\pm 2^\circ 30'$  (excluding cut-outs marked a and b).
- Tightening torque of screws ZBZ006: 0.6 N.m (5.3 lbf.in) max.
- Allow for one ZB5AZ079 fixing collar/pillar and its fixing screws:
  - every 90 mm / 3.54 in. horizontally (X), and 120 mm / 4.72 in. vertically (Y).
  - with each selector switch head (ZB5AD\*, ZB5AJ\*, ZB5AG\*).

The fixing centers marked a and b are diagonally opposed and must align with those marked 4 and 5.

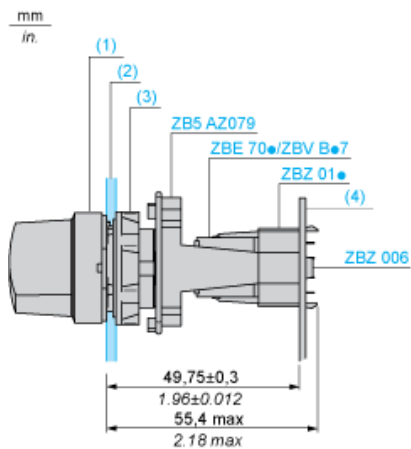

- (1) Head ZB5AD\*  
(2) Panel  
(2) Nut  
(4) Printed circuit board

## Mounting of Adapter (Socket) ZBZ01•

- 1 2 elongated holes for ZBZ006 screw access
- 2 1 hole  $\varnothing$  2.4 mm  $\pm$  0.05 / 0.09 in.  $\pm$  0.002 for centring adapter ZBZ01•
- 3 8  $\times$   $\varnothing$  1.2 mm / 0.05 in. holes
- 4 1 hole  $\varnothing$  2.9 mm  $\pm$  0.05 / 0.11 in.  $\pm$  0.002, for aligning the printed circuit board (with cut-out marked a)
- 5 1 elongated hole for aligning the printed circuit board (with cut-out marked b)
- 6 4 holes  $\varnothing$  2.4 mm / 0.09 in. for clipping in adapter ZBZ01•

Dimensions An + 18.1 relate to the  $\varnothing$  2.4 mm  $\pm$  0.05 / 0.09 in.  $\pm$  0.002 holes for centring adapter ZBZ01•.

---

Electrical Composition Corresponding to Code C1

---





---

Electrical Composition Corresponding to Code C2

---



---

Electrical Composition Corresponding to Codes C9, C11, SF1 and SR1

---



---

Electrical Composition Corresponding to Code C15

---

1 N/O

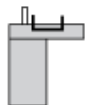

1 N/C

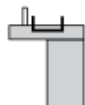

1 N/O + N/C or 1 N/O + N/O or 1 N/C + N/C

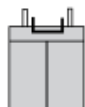

---

Legend

---

Single contact



Double contact



Light block



Possible location

