

Betaduct PVC Closed Slot Cable Trunking

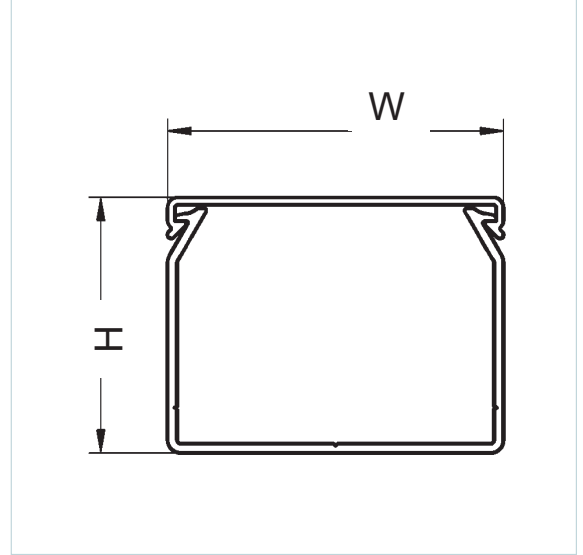

Specification

Material	Rigid PVC 9051 LF
Colour	Grey RAL7030, Black RAL9005
Operating Temp	-5°C to +60°C
Volume Resistivity	1 E15 Ohm. cm
Dielectric Strength	15 kV/mm
Flame Resistance	VO UL94
Tensile Strength	>40 MPa
Ultimate Elongation	>160%
Fire Rating	DIN 5510-2 S3-SR1-ST2
Weather Resistance	Good
Stabilization	Calcium / Zinc
Glow Wire Flammability	+960°C
UL Recognised	UL 1565 E509564
CSA Recognised	CSA-C22.2 No. 18.5 E509564

Key Features

- Lightweight and self-extinguishing
- Excellent rigidity and performance characteristics
- Easy installation
- Base holes to DIN 43659*
*100mm height base holes to EN 50085-2-3
- Break points on fingers and bas
- Secure clip on lid
- Supplied in 2m lengths

Spare lids available













Part Number		Nominal External (mm)		Lengths Per Pack	Quantity Per Pack (m)
Grey	Black	Height	Width		
10460022Y	09510000Y	37.5	25	12	24
10460023Y	09030000Y	50	25	12	24
10460024Y	09040000Y	75	25	8	16
10460032Y	09540000Y	37.5	37.5	12	24
10460033Y	09550000Y	50	37.5	8	16
10460034Y	09560000Y	75	37.5	8	16

Betaduct PVC Closed Slot Cable Trunking

Part Number		Nominal External (mm)		Lengths Per Pack	Quantity Per Pack (m)
Grey	Black	Height	Width		
10460052Y	09590000Y	37.5	50	12	24
10460053Y	09060000Y	50	50	8	16
10460054Y	09070000Y	75	50	8	16
10460055Y		100	50	4	8
10460073Y	09640000Y	50	75	8	16
10460074Y	09090000Y	75	75	8	16
10460075Y		100	75	4	8
10460103Y		50	100	4	8
10460104Y		75	100	4	8
10460105Y		100	100	4	8
10460124Y	09400000Y	75	125	4	8
10460155Y		100	150	4	8

You might also need...

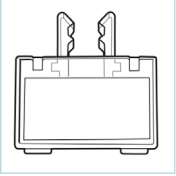
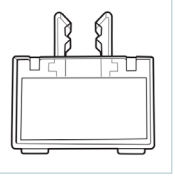
<p>EDC1</p>  <p>Betaduct Trunking Cutting Tool</p> <ul style="list-style-type: none"> • Blade W: 21.5mm • Cutting D: 50mm 	<p>BETADUCT-CUTTER</p>  <p>Betaduct Trunking Cutting Tool</p> <ul style="list-style-type: none"> • Cuts up to 125mm 	<p>EDC 2</p>  <p>Betaduct Trunking Cutting Tool</p> <ul style="list-style-type: none"> • Cuts up to 110mm 	<p>1857</p>  <p>Betaduct Trunking Cutting Tool</p> <ul style="list-style-type: none"> • Ideal for cutting slots in trunking 	<p>RT4 or RT6</p>  <p>Betaduct Trunking Rivet Tools</p> <ul style="list-style-type: none"> • 4.5mm (RT4) • 6.5mm (RT6) 	<p>DUCTAFIX R4 or R6</p>  <p>Betaduct Trunking Rivets</p> <ul style="list-style-type: none"> • 4mm (R4) • 6mm (R6)
<p>10440000</p>  <p>Betaduct Insulating Washers</p> <ul style="list-style-type: none"> • Black • Pack of 50 	<p>RC1</p>  <p>Retaining Clip For Narrow Trunking</p> <ul style="list-style-type: none"> • 53mm x 66mm • Pack of 50 	<p>BC1</p>  <p>HF Bridging Clip For Narrow Trunking</p> <ul style="list-style-type: none"> • 22.5mm x 105mm • Pack of 50 	<p>BC2</p>  <p>HF Bridging Clip For Narrow Trunking</p> <ul style="list-style-type: none"> • 24mm x 108mm • Pack of 50 	<p>LH1</p>  <p>Label Holder For Narrow Trunking</p> <ul style="list-style-type: none"> • 25.5mm x 13mm • Pack of 50 	<p>LH2</p>  <p>Label Holder For Narrow Trunking</p> <ul style="list-style-type: none"> • 38mm x 19mm • Pack of 50

Betaduct PVC Closed Slot Cable Trunking

H = 37.5 mm

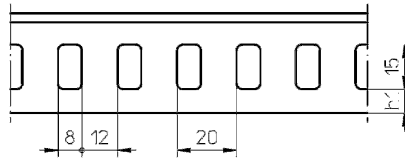
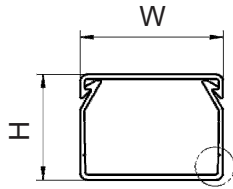

W = 25, 37.5, and 50 mm

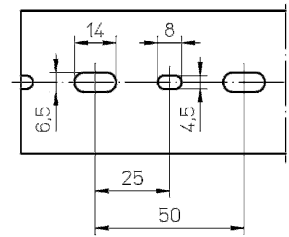

H = 50 mm

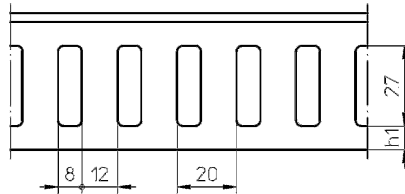
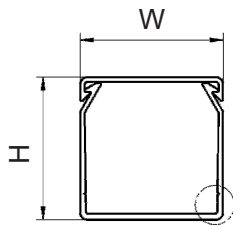

W = 75, 100 and 125mm

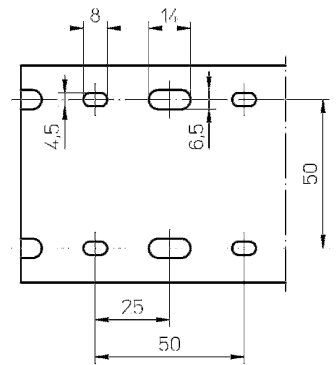

H = 75 mm

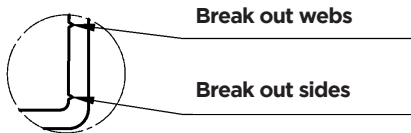
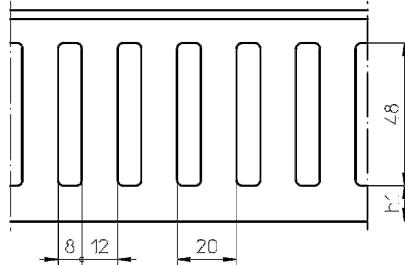
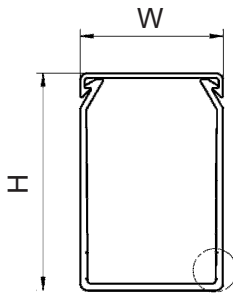

Base punching to DIN 43659

H (mm)	37.5	50	75
h1 (mm)	8	8	12

Betaduct Trunking Capacity Chart

Trunking Nominal External Width x Height (mm)	Internal Cross Sectional Area (mm ²)	At 50% Packing Density (mm ²)	Cable Cross Sectional Area (mm ²) Tri-Rated Cable BS6231														
			Cable Diameter (mm)														
			0.50	0.75	1.00	1.50	2.50	4.00	6.00	10.00	16.00	25.00	35.00	50.00	70.00	95.00	
25 x 37.5	608	304	55	48	43	35	28	19	16	9	4	3	2	1	1	1	1
25 x 50	836	418	76	66	59	48	38	27	22	12	6	4	3	2	1	1	1
25 x 75	1311	655.5	120	104	92	76	60	43	34	19	10	7	5	3	3	2	2
37.5 x 37.5	1024	512	94	81	72	59	47	33	27	15	7	5	4	2	2	1	1
37.5 x 50	1408	704	129	111	99	82	65	46	37	21	10	8	6	4	3	2	2
37.5 x 75	2208	1104	203	175	156	129	102	72	58	33	17	12	9	6	5	3	3
50 x 37.5	1408	704	129	111	99	82	65	46	37	21	10	8	6	4	3	2	2
50 x 50	1936	968	178	153	136	113	90	63	51	29	15	11	8	5	4	3	3
50 x 75	3036	1518	279	241	214	177	141	99	80	45	23	17	13	8	7	5	5
50 x 100	4136	2068	380	328	292	241	192	136	109	62	32	23	18	12	9	7	7
75 x 37.5	2208	1104	203	175	156	129	102	72	58	33	17	12	9	6	5	3	3
75 x 50	3036	1518	279	241	214	177	141	99	80	45	23	17	13	8	7	5	5
75 x 75	4761	2380.5	438	378	336	278	221	156	126	71	37	27	21	13	11	8	8
75 x 100	6486	3243	596	515	458	379	301	213	171	97	50	37	29	18	15	11	11
100 x 50	4136	2068	380	328	292	241	192	136	109	62	32	23	18	12	9	7	7
100 x 75	6486	3243	596	515	458	379	301	213	171	97	50	37	29	18	15	11	11
100 x 100	8836	4418	813	702	625	516	410	290	234	133	68	50	39	25	20	16	16
150 x 100	13536	6768	1245	1075	957	791	629	445	358	203	105	77	60	39	31	24	24
125 x 75	8142	4071	749	647	575	475	378	267	215	122	63	46	36	23	18	14	14