

## Data sheet | Item number: 224-101

Power supply connector; 2,50 mm<sup>2</sup>; gray

[www.wago.com/224-101](http://www.wago.com/224-101)

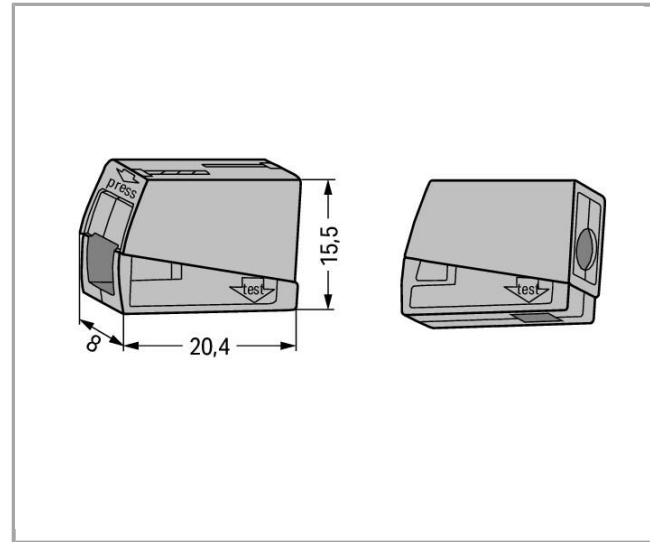
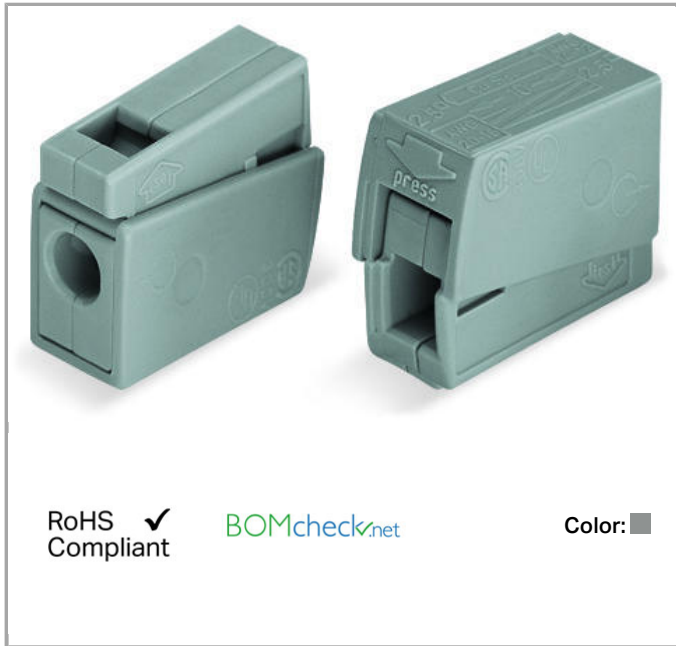

### Item description

#### Note:

#### Terminating Aluminum Conductors

WAGO spring clamp terminal blocks are suitable for solid aluminum conductors up to 4 mm<sup>2</sup>/12 AWG if WAGO "Alu-Plus" Contact Paste is used for termination.

#### "Alu-Plus" Contact Paste Advantages:

- Automatically destroys the oxide film during clamping.
- Prevents fresh oxidation at the clamping point.
- Prevents electrolytic corrosion between aluminum and copper conductors (in the same terminal block).
- Provides long-term protection against corrosion.

Using terminal blocks with PUSH WIRE® Spring Pressure Connection Technology, **aluminum conductors must first be cleaned with a blade and then immediately be inserted into the clamping units filled with "Alu-Plus" Contact Paste.**

It is also possible to apply WAGO "Alu-Plus" **additionally** on the whole surface of the aluminum conductor before termination.

Please note that the nominal currents must be adapted to the reduced conductivity of the aluminum conductors:

2.5 mm<sup>2</sup> (14 AWG) = 16 A

4 mm<sup>2</sup> (12 AWG) = 22 A

#### Safety information 1:

In grounded power lines

## Data

### Electrical data

#### Ratings per IEC/EN 60664-1

Rated voltage (II / 2)	400 V
Rated impulse voltage (II / 2)	4 kV
Rated current	24 A

### Connection data

Connection type (1)	Installation side:
Connection technology	PUSH WIRE®
Actuation type	Push-in
Connectable conductor materials	Copper Aluminum
Solid conductor	1 ... 2.5 mm <sup>2</sup> / 14 ... 12 AWG
Strip length	9 ... 11 mm / 0.35 ... 0.43 inch
Connection type (2)	Lighting side:
Connection technology 2	CAGE CLAMP®
Number of connection points	1
Solid conductor (2)	0.5 ... 2.5 mm <sup>2</sup> / 20 ... 16 AWG
Total number of connection points	2
Total number of potentials	1
Type of wiring	Side-entry wiring
Fine-stranded conductor (2)	0.5 ... 2.5 mm <sup>2</sup> / 20 ... 16 AWG
Leiterquerschnitte eindrätig	0.5 mm <sup>2</sup>

### Geometrical Data

Width	8 mm / 0.315 inch
Height	15.5 mm / 0.61 inch
Depth	20.4 mm / 0.803 inch

### Material Data

Color	gray
Fire load	0.041 MJ
Weight	2.128 g

### Environmental Requirements

Continuous operating temperature	105 °C
----------------------------------	--------

## Commercial data





Country of origin	CH
GTIN	4044918583817

## Approvals / Certificates

### Country specific Approvals

Logo	Approval	Additional Approval Text	Certificate name
	VDE VDE Prüf- und Zertifizierungsinstitut	EN 60998	40022792

### Ship Approvals

Logo	Approval	Additional Approval Text	Certificate name
	ABS American Bureau of Shipping	-	18- HG1755093- PDA
	BV Bureau Veritas S.A.	EN 60998	11914/C0 BV
	DNV GL Det Norske Veritas, Germanischer Lloyd	EN 60998	TAE000015T
	LR Lloyds Register	EN 60998	04/20013 (E8)

### UL-Approvals

Logo	Approval	Additional Approval Text	Certificate name
	UL UL International Germany GmbH	EN 60998	CCA- 2617-A1
	UL UL International Germany GmbH	EN 60998	D-05895- A1 (EN60998- 1 EN60998- 2-2)
	UL	UL 486C	E69654



UL International Germany GmbH

## Compatible products

### General accessories



Item no.: 249-130

Syringe; Contents: 20 ml Alu-Plus contact paste

[www.wago.com/249-130](http://www.wago.com/249-130)

## Downloads

### Documentation

#### Additional Information

Technical explanations	Apr 3, 2019	pdf 2.1 MB	Download
------------------------	-------------	---------------	----------

## CAD/CAE - Smart Data

### CAD data

3D Download 224-101	URL	Download
---------------------	-----	----------

### EPLAN

EPLAN Data Portal	Download
-------------------	----------

### WSCAD

WSCAD Universe	Download
----------------	----------

Subject to changes.

WAGO Kontakttechnik GmbH & Co. KG  
Hansastr. 27  
32423 Minden  
Phone: +49571 887-0 | Fax: +49571 887-169  
Email: [info.de@wago.com](mailto:info.de@wago.com) | Web: [www.wago.com](http://www.wago.com)

Do you have any questions about our products?  
We are always happy to take your call at 01788 568 008.