

# Efficient, flexible and simple signaling



Eaton's signal towers are devices that use light and sound to indicate the operating states of machines, systems and processes. They come in three types: the modular SL4 and SL7, and the non-modular compact SLC. The SL4/SL7 modular types can be customized with different coloured LED lights and acoustic modules, while the SLC compact type has three fixed colours and optional acoustic modules. Eaton's signal towers are versatile, reliable, easy to install and configure for various applications.



*Powering Business Worldwide*

# Features

## Efficient

Eaton's stack lights offer all the features you will need for easy and clear system status identification.

Six colors for the international market: red, yellow, green, blue, clear and orange (amber).

Lighting variants: continuous illumination light, flashing light, strobe light, variable strobe light.

Acoustic modules with up to 8 different signals and adjustable volume levels for optimal adaptation to any ambient condition.

LED and high performance LEDs for better brightness.

Communication: The SL7 portfolio supports all current AS-i versions and SmartWire-DT connection for easy integration of SL7 signal towers.



IP66 rating for protection against dust and water.

UV protected plastic material

Red blinking light

3 colors red yellow and green

>70db acoustic tone module, pulse tone \_ \_ \_



# Features

## Three different sized products

Eaton's signal towers come in 3 different sizes giving you the option to choose the correct device for your needs, based on factors such as space, visibility, sound and functionality.



## Sound modules

The optional acoustic modules (up to 100db) are an easy but powerful way to hear if the application requires immediate attention



## Bright LEDs

The SL4/SL7 6 coloured LEDs light modules can be stacked on top of each other, in the quantity (up to 5) and order of your choice, to clearly visually indicate the status of the machines, processes or systems: such as ready, busy, error, emergency, or maintenance.

The SLC's simple and intuitive three colors of red, yellow, and green are universally recognized as stop, caution, and go signals. They do not require any special training or interpretation to understand the meaning of each light.



 Precise classification of information thanks to six colors

# Features

## Many base modules

### SL4/SL7

There are up to 11 base modules giving you the flexibility to select a base module that can be mounted on the location and the orientation of your choice.



### SLC

There are 3 variants available: standard base module, wall mounted and hole mounting.



## Quick mounting

The rapid mounting and wiring system with bayonet fitting means that the electrical wiring only needs to be connected once, with the lower portion simply remaining on the machine. If the machine needs to be transported to another location, the signal tower can be remounted immediately and effortlessly.

The complete stacklight can be easily assembled with a simple twist



Transport cover for cables and connections protection



SLC

The hole mounting SLC variant, using the standard 22mm hole, is fitted with an M12 plug for quick installation.



# Features

## Customizable











With our online configurator, you can customize your SL4 and SL7 stack lights to fit your requirements. You can select the different types of lights and mounting modules. You will see a realistic preview of how your signal towers will look. The tool also creates a list of items that you can send directly to Eaton or your preferred distributor.



# Technical data

	SL4	SL7	SLC
<b>Voltage</b>	24V, 120V and 230 V	24V, 120V and 230 V	24V, 120V and 230 V
<b>IP Protection</b>	IEC IP66, UL Type 4, 4X, 13	IEC IP66, UL Type 4, 4X, 13	IEC IP66, UL Type 4, 4X, 13
<b>Standards</b>	IEC/EN 60947-5-1, UL	IEC/EN 60947-5-1, UL	IEC/EN 60947-5-1, UL
<b>Ambient temperature</b>	-30 ...+60° C	-30 ...+60° C	-25 ...+50° C
<b>Lights</b>			
<b>Light module diameter</b>	43 mm	73 mm	61 mm
<b>Type of lights</b>	Continuous, flashing, strobe	Continuous, flashing, strobe and high performance which is superbright	Continuous, flashing, strobe
<b>Customisable</b>	Yes	Yes	No
<b>Light colours</b>	Red, yellow, green, blue, clear and orange (amber)	Red, yellow, green, blue, clear and orange (amber)	Red, yellow, green
<b>Acoustic</b>			
<b>Optional acoustic module</b>	Yes	Yes	Yes
<b>Acoustic level</b>	80 dB	100 dB	70 dB
<b>Type of tones</b>	Continuous or pulse	Continuous, pulse and multi-tone (8 tones)	Pulse tone
<b>Mounting options</b>			
<b>Number of mounting options</b>	10	11	3
<b>Terminals</b>	<ul style="list-style-type: none"> <li>• Push-in terminals</li> </ul>	<ul style="list-style-type: none"> <li>• 5-pole M12 plug-in</li> <li>• Spring cage terminals</li> <li>• Push-in terminals</li> </ul>	<ul style="list-style-type: none"> <li>• 5-pole M12 plug-in</li> <li>• Push-in terminals</li> </ul>
<b>Base height</b>	100, 250, 400, 800 mm	100, 250, 400, 800 mm	100 mm

## SLC Stack Light Compact range overview

	Rated operational voltage	Module without acoustic		Module with acoustic pulse tone -----	
		Part no. Article no.	Light status icons	Part no. Article no.	Light status icons
<b>Complete devices with standard base</b>					
	24 VDC	SLC-100-RYG-24 EP-400208		SLC-100-RYG-AP-24 EP-400211	
	24 VUC*	SLC-100-RYG-24UC EP-400194		SLC-100-RYG-AP-24UC EP-400197	
	120 VAC	SLC-100-RYG-120 EP-400200		SLC-100-RYG-AP-120 EP-400202	
	230 VAC	SLC-100-RYG-230 EP-400214		SLC-100-RYG-AP-230 EP-400216	
<b>Complete devices with M22 hole mounting and M12 plug</b>					
	24 VDC	SLC-M22-RYG-24 EP-400210		SLC-M22-RYG-AP-24 EP-400213	
	24 VUC*	SLC-M22-RYG-24UC EP-400196		SLC-M22-RYG-AP-24UC EP-400199	
<b>Complete devices with wall base</b>					
	24 VDC	SLC-FW-RYG-24 EP-400209		SLC-FW-RYG-AP-24 EP-400212	
	24 VUC*	SLC-FW-RYG-24UC EP-400195		SLC-FW-RYG-AP-24 EP-400198	
	120 VAC	SLC-FW-RYG-120 EP-400201		SLC-FW-RYG-AP-120 EP-400203	
	230 VAC	SLC-FW-RYG-230 EP-400215		SLC-FW-RYG-AP-230 EP-400217	

\* UC = universal current (AC/DC)

## Dimensions

### Standard base SLC-100-RYG

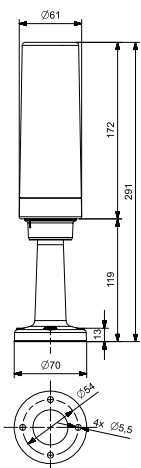

### M22 hole mounting SLC-M22-RYG

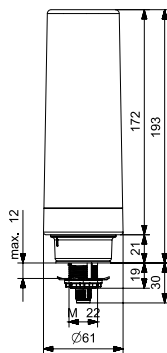

### Wall mounting SLC-FW-RYG

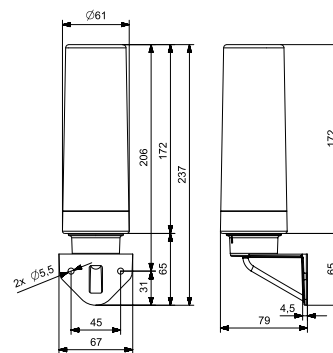

## SL4 and SL7 Complete devices and base modules

Rated operational voltage U <sub>e</sub> V	Number of modules	Color	Module diameter 70 mm	Module diameter 40 mm
			Part no. Article no.	Part no. Article no.

### Complete devices (IP66)

Complete Units



24 V AC/DC

2		SL7-100-L-RG-24LED 171424	SL4-100-L-RG-24LED 171295
3		SL7-100-L-RYG-24LED 171425	SL4-100-L-RYG-24LED 171296
3		SL7-100-L-RAG-24LED 173982	SL4-100-L-RAG-24LED 173981

### Customized complete devices

Connection to pushbutton configurator

To use the Eaton Pushbutton Configurator, visit: [www.eaton.com/config/rmq](http://www.eaton.com/config/rmq)

-	-	SL7-COMBINATION 2011955	SL4-COMBINATION 2011956
---	---	----------------------------	----------------------------

Description	Tube length	For use with	Part no. article no.	For use with	Part no. Article no.
-------------	-------------	--------------	-------------------------	--------------	-------------------------

### Base modules

For horizontal mounting  
Includes cover  
max. 5 modules

Description	Tube length	For use with	Spring-loaded terminals	Push-in terminals
			Part no. article no.	Part no. Article no.
All base modules section will be replaced as after complete device.	100 mm		SL7-CB-100 171443	SL4-PIB-100 171297
	250 mm		SL7-CB-250 171444	SL4-PIB-250 171298
	400 mm		SL7-CB-400 171445	SL4-PIB-400 171299
	800 mm	SL7-L-... SL7-BL-... SL7-FL-... SL7-AP-...	SL7-CB-800 177312	SL4-L-... SL4-BL-... SL4-FL-... SL4-AP-... SL4-PIB-800 177313
All base modules section will be replaced as after complete device.	100 mm		SL7-CB-T-100 171452	SL4-PIB-T-100 171305
	250 mm		SL7-CB-T-250 171453	SL4-PIB-T-250 171306
	400 mm		SL7-CB-T-400 171454	SL4-PIB-T-400 171307
	800 mm		SL7-CB-T-800 178460	SL4-PIB-T-800 178461



## SL4 and SL7 Base modules

Description	Tube length	For use with	Part no. article no.	For use with	Part no. Article no.
Base modules For horizontal mounting Includes cover max. 5 modules					
			<b>Spring-loaded terminals</b>		<b>Push-in terminals</b>
 Base with internal fixing holes	-		<b>SL7-CB-IMH</b> 171447		<b>SL4-PIB-IMH</b> 171300
 Base with built-in (pre-assembled) fixing screws	-	SL7-L-... SL7-BL-...	<b>SL7-CB-IMS</b> 171448	SL4-L-... SL4-BL-...	<b>SL4-PIB-IMS</b> 171301
 Base with external fixing holes	-	SL7-FL-... SL7-AP-...	<b>SL7-CB-EMH</b> 171449	SL4-FL-... SL4-AP-...	<b>SL4-PIB-EMH</b> 171302
 Base: can hold tubes with a diameter of 25 mm (±0.5)	-		<b>SL7-CB-TM</b> 179987		<b>SL4-PIB-TM</b> 179986
<b>Base with fast mounting system</b>					
			<b>Screw terminals</b>		<b>Screw terminals</b>
	100 mm		<b>SL7-FMS-100</b> 171456		<b>SL4-FMS-100</b> 171308
	250 mm		<b>SL7-FMS-250</b> 171457		<b>SL4-FMS-250</b> 171309
	400 mm		<b>SL7-FMS-400</b> 171458		<b>SL4-FMS-400</b> 171310
	800 mm		<b>SL7-FMS-800</b> 178462		<b>SL4-FMS-800</b> 178463
			<b>Blade terminal SWD4-8MF2</b>		<b>Blade terminal SWD4-8MF2</b>
 max. 5 modules max. 0.3 A per module An external power supply can be connected (24 V DC) Configurable with the SWD Assist planning and ordering tool	100 mm		<b>SL7-SWD</b> 171459		<b>SL4-SWD</b> 171311
<b>Identical to SL7-FMS... and SL7-SWD</b>					
	max. 4 modules AS-Interface version 2.0 Power supply via AS-i (max. 190 mA)		<b>SL7-FMS-ASI-V20</b> 197318		-
	max. 4 modules AS-Interface version 2.0 Power supply via external source (24 V DC)		<b>SL7-FMS-ASI-V20E</b> 197319		-
	max. 3 modules AS-Interface version 2.1 Power supply via AS-i (max. 190 mA)		<b>SL7-FMS-ASI-V21</b> 197320		-
	max. 3 modules AS-Interface version 2.1 Power supply via external voltage source (24 V DC)	100 mm	SL7-L(24)-... SL7-BL24-... SL7-FL24-... SL7-AP24-...	<b>SL7-FMS-ASI-V21E</b> 197321	-
	max. 4 modules AS-Interface version 3.0 Power supply via AS-i (max. 190 mA)		<b>SL7-FMS-ASI-V30</b> 197322		-
	max. 4 modules AS-Interface version 3.0 Power supply via external voltage source (24 V DC)		<b>SL7-FMS-ASI-V30E</b> 197323		-























## SL4 and SL7 Base modules and light modules











Description	Tube length	For use with	Part no. Article no.	For use with	Part no. Article no.
<b>For vertical mounting Includes cover</b>					
			<b>Spring-loaded terminals</b>		<b>Push-in terminals</b>
 One-sided base with bracket max. 5 modules	-	SL7-L-... SL7-BL-... SL7-FL-... SL7-AP-...	SL7-CB-FW 171450	SL4-L-... SL4-BL-... SL4-FL-... SL4-AP-...	SL4-PIB-FW 171303
<b>For vertical mounting on both sides Includes cover</b>					
			<b>Spring-loaded terminals</b>		<b>Push-in terminals</b>
 Base with external fixing holes Max. 2 x 5 modules	-	SL7-L-... SL7-BL-... SL7-FL-... SL7-AP-...	SL7-CB-D 171451	SL4-L-... SL4-BL-... SL4-FL-... SL4-AP-...	SL4-PIB-D 171304
<b>For vertical mounting on one side Includes cover</b>					
			<b>M12A plug, 4-pole</b>		
 Base with external fixing holes max. 3 modules	-	SL7-L-... SL7-BL-... SL7-FL-... SL7-AP-...	SL7-CB-D-M12A4 177351		
<b>Module with LED, IP66</b>					
	Rated operational voltage <sup>1)</sup> U <sub>e</sub> V	Color	Continuous light	Flashing light 2 Hz	Strobe light 1.4 Hz
			Part no. Article no.	Part no. Article no.	Part no. Article no.
24 V AC/DC			 SL7-L24-B 171461	SL7-BL24-B 171439	SL7-FL24-B 171402
			 SL7-L24-G 171462	SL7-BL24-G 171440	SL7-FL24-G 171403
			 SL7-L24-R 171463	SL7-BL24-R 171441	SL7-FL24-R 171404
			 SL7-L24-W 171464	SL7-BL24-W 171442	SL7-FL24-W 171405
	 SL7-L24-Y 171465	SL7-BL24-Y 171388	SL7-FL24-Y 171406		
	 SL7-L24-A 171466	SL7-BL24-A 171389	SL7-FL24-A 171407		
230/240 V AC	 SL7-L230-B 171473	SL7-BL230-B 171396	SL7-FL230-B 171414		
	 SL7-L230-G 171474	SL7-BL230-G 171397	SL7-FL230-G 171415		
	 SL7-L230-R 171475	SL7-BL230-R 171398	SL7-FL230-R 171416		
	 SL7-L230-W 171476	SL7-BL230-W 171399	SL7-FL230-W 171417		
	 SL7-L230-Y 171477	SL7-BL230-Y 171400	SL7-FL230-Y 171418		
	 SL7-L230-A 171426	SL7-BL230-A 171401	SL7-FL230-A 171419		

**Note:** <sup>1)</sup> 110/120 V AC - online catalog

## SL4 and SL7 Light modules and acoustic modules





	Rated operational voltage <sup>1)</sup> U <sub>e</sub> V	Color	Continuous light	Flashing light 2 Hz	Strobe light 1.4 Hz	Multistrobe light 1 - 2.6 Hz
			Part no. Article no.	Part no. Article no.	Part no. Article no.	Part no. Article no.
<b>High-performance LED module, IP66</b>						
	24 V AC/DC		SL7-L24-B-HP 171427	-	SL7-FL24-B-HP 171420	SL7-FL24-B-HPM 171275
			SL7-L24-G-HP 171428	-	SL7-FL24-G-HP 171421	SL7-FL24-G-HPM 171276
			SL7-L24-R-HP 171429	-	SL7-FL24-R-HP 171422	SL7-FL24-R-HPM 171277
			SL7-L24-W-HP 171430	-	SL7-FL24-W-HP 171423	SL7-FL24-W-HPM 171278
			SL7-L24-Y-HP 171431	-	SL7-FL24-Y-HP 171273	SL7-FL24-Y-HPM 171279
			SL7-L24-A-HP 171432	-	SL7-FL24-A-HP 171274	SL7-FL24-A-HPM 171280
<b>Module with LED, IP66</b>						
	24 V AC/DC		SL4-L24-B 171313	SL4-BL24-B 171337	SL4-FL24-B 171355	SL4-FL24-B-M 171373
			SL4-L24-G 171314	SL4-BL24-G 171338	SL4-FL24-G 171356	SL4-FL24-G-M 171374
			SL4-L24-R 171315	SL4-BL24-R 171339	SL4-FL24-R 171357	SL4-FL24-R-M 171375
			SL4-L24-W 171316	SL4-BL24-W 171340	SL4-FL24-W 171358	SL4-FL24-W-M 171376
			SL4-L24-Y 171317	SL4-BL24-Y 171341	SL4-FL24-Y 171359	SL4-FL24-Y-M 171377
			SL4-L24-A 171318	SL4-BL24-A 171342	SL4-FL24-A 171360	SL4-FL24-A-M 171378
	230/240 V AC		SL4-L230-B 171325	SL4-BL230-B 171349	SL4-FL230-B 171367	-
			SL4-L230-G 171326	SL4-BL230-G 171350	SL4-FL230-G 171368	-
			SL4-L230-R 171327	SL4-BL230-R 171351	SL4-FL230-R 171369	-
			SL4-L230-W 171328	SL4-BL230-W 171352	SL4-FL230-W 171370	-
			SL4-L230-Y 171329	SL4-BL230-Y 171353	SL4-FL230-Y 171371	-
			SL4-L230-A 171330	SL4-BL230-A 171354	SL4-FL230-A 171372	-

1) 110/120 V AC - online catalog

Description	Rated operating voltage <sup>1)</sup> U <sub>e</sub> V	Rated operational current I <sub>e</sub> mA	Color	Type of tone	Part no. Article no.
					Part no. Article no.
<b>Acoustic modules, IP66</b>					
Place only at the highest position of a tower.					
	Continuous tone or pulsed tone, adjustable with internal dip switch.	24 V AC/DC	max. 92		SL7-AP24 171281
	Sound pressure: 100 db, adjustable via an internal potentiometer f = 2800 Hz	230/240 V AC	max. 43		SL7-AP230 171283
	Continuous tone or pulsed tone, external actuation. Assigned two inputs (2 modules).	24 V AC/DC	max. 92		SL7-AP24-E 171284
	Sound pressure: 100 db, adjustable via an internal potentiometer f = 2800 Hz	230/240 V AC	max. 43		SL7-AP230-E 171286
	Multi-tone; 8 tones, adjustable via an internal dip switch.	24 V AC/DC	max. 115		SL7-AP24-M 171287
	Sound pressure: 100 db, adjustable via an internal potentiometer f = 500 - 2700 Hz	230/240 V AC	max. 43		SL7-AP230-M 171289
	Continuous tone or pulsed tone, adjustable via an internal dip switch.	24 V AC/DC	max. 39		SL4-AP24 171379
	Sound pressure: 80 dB. f = 4000 Hz	230/240 V AC	max. 21		SL4-AP230 171381

**Note:** <sup>1)</sup> 110/120 V AC - online catalog

## SL4 and SL7 Accessories

	Lifespan h	Rated operational voltage U <sub>e</sub> V	Power	For use with	Part no. Article no.
<b>Magnetic base, includes M20 cable gland</b>					
For vertical mounting, metal and plastic					
	-	-	-	SL4-PIB-100(250)(400) SL7-CB-100(250)(400)	SL7/4-MMS 172954
<b>Mounting bracket</b>					
For vertical mounting, plastic					
	-	-	-	SL4-PIB-100(250)(400) SL4-FMS... SL7-CB-100(250)(400) SL7-FMS...	SL7/4-FW 171446
<b>Mounting bracket, includes M20 cable gland</b>					
For vertical mounting, metal					
	-	-	-	SL4-PIB-T... SL7-CB-T...	SL7/4-FW-T 171455
<b>Replacement cover</b>					
for signal towers					
	-	-	-	SL7-... SL4-...	SL7-COV 192368 SL4-COV 192369

Eaton is an intelligent power management company dedicated to improving the quality of life and protecting the environment for people everywhere. We are guided by our commitment to do business right, to operate sustainably and to help our customers manage power – today and well into the future. By capitalizing on the global growth trends of electrification and digitalization, we're accelerating the planet's transition to renewable energy, helping to solve the world's most urgent power management challenges, and doing what's best for our stakeholders and all of society.

For more information, visit [www.eaton.com](https://www.eaton.com).

Eaton addresses worldwide: [Eaton.com/contacts](https://www.eaton.com/contacts)



#### **Eaton**

EMEA Headquarters  
Route de la Longeraie 7  
1110 Morges, Switzerland  
[Eaton.com](https://www.eaton.com)

#### **Electrical Sector**

Eaton Industries GmbH  
Hein-Moeller-Str. 7-11  
53115 Bonn  
Germany

© 2024 Eaton  
All Rights Reserved  
Publication No. BR047017EN  
February 2024

The products, information and prices contained in this document are subject to change. The same is true for any errors or omissions. Only the order confirmation and the technical documentation received from Eaton are binding. Photos and illustrations are indicative only and do not serve as proof of any appearance or functionality. Their use in any form must be approved in advance by Eaton. The same applies for brand names (in particular Eaton, Moeller, Cutler-Hammer, Cooper and Bussmann). Eaton's terms of sale, as published on Eaton's websites and included with order confirmations received from Eaton, apply.

Eaton is a registered trademark.

All other trademarks are property of their respective owners.