

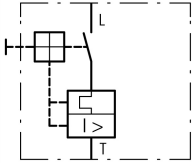



**Motor-protective circuit-breaker, 3p, Ir=0.25-0.4A**

**Part no.** PKZM01-0,4  
**Catalog No.** 278477  
**Eaton Catalog No.** XTPBP40BC1  
**EL-Nummer (Norway)** 0004365012

**Delivery program**

Product range				PKZM01 motor protective circuit-breakers up to 16 A with pushbutton actuation
Basic function				Motor protection
				
Notes				Also suitable for motors with efficiency class IE3. IE3-ready devices are identified by the logo on their packaging.
Connection technique				Screw terminals
Contact sequence				
<b>Max. motor rating</b>				
AC-3				
220 V 230 V 240 V	P	kW		0.06
380 V 400 V 415 V	P	kW		0.09
440 V	P	kW		0.12
500 V	P	kW		0.12
660 V 690 V	P	kW		0.18
Rated uninterrupted current	$I_u$	A		0.4
<b>Setting range</b>				
Overload releases				
	$I_r$	A		0.25 - 0.4
short-circuit release				
				
max.	$I_{rm}$	A		6.2
Phase-failure sensitivity				IEC/EN 60947-4-1, VDE 0660 Part 102
<b>Notes</b> Overload trigger: tripping class 10 A Can be snapped on to IEC/EN 60715 top-hat rail with 7.5 or 15 mm height.				

**Technical data**

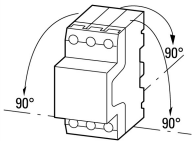
<b>General</b>				
Standards				IEC/EN 60947, VDE 0660, UL, CSA
Climatic proofing				Damp heat, constant, to IEC 60068-2-78 Damp heat, cyclic, to IEC 60068-2-30
Ambient temperature				
Storage		°C		- 40 - 80
Open		°C		-25 - +55
Enclosed		°C		- 25 - 40
Mounting position				
Direction of incoming supply				as required

Degree of protection			
Device			IP20
Terminations			IP00
Protection against direct contact when actuated from front (EN 50274)			Finger and back-of-hand proof
Mechanical shock resistance half-sinusoidal shock 10 ms to IEC 60068-2-27		g	25
Altitude		m	Max. 2000
Terminal capacity main cable			
Screw terminals			
Solid		mm <sup>2</sup>	1 x (1 - 6) 2 x (1 - 6)
Flexible with ferrule to DIN 46228		mm <sup>2</sup>	1 x (1 - 6) 2 x (1 - 6)
Solid or stranded		AWG	18 - 10
Stripping length		mm	10
Specified tightening torque for terminal screws			
Main cable		Nm	1.7

### Main conducting paths

Rated impulse withstand voltage	U <sub>imp</sub>	V AC	6000
Overvoltage category/pollution degree			III/3
Rated operational voltage	U <sub>e</sub>	V AC	690
Rated uninterrupted current = rated operational current	I <sub>u</sub> = I <sub>e</sub>	A	0.4
Rated frequency	f	Hz	40 - 60
Current heat loss (3 pole at operating temperature)		W	5.22
Lifespan, mechanical	Operations	x 10 <sup>6</sup>	0.05
Lifespan, electrical (AC-3 at 400 V)			
Lifespan, electrical	Operations	x 10 <sup>6</sup>	0.05
Max. operating frequency		Ops/h	25
Short-circuit rating			
DC			
Short-circuit rating		kA	60
Notes			up to 250 V
Motor switching capacity			
AC-3 (up to 690V)		A	0.4
DC-5 (up to 250V)		A	0.4 (3 contacts in series)

### Trip blocks

Temperature compensation			
to IEC/EN 60947, VDE 0660		°C	- 5 ... 40
Operating range		°C	- 25 ... 55
Temperature compensation residual error for T > 40 °C			≤ 0.25 %/K
Setting range of overload releases		x I <sub>u</sub>	0.6 - 1
short-circuit release			Basic device, fixed: 15.5 x I <sub>u</sub>
Short-circuit release tolerance			± 20%
Phase-failure sensitivity			IEC/EN 60947-4-1, VDE 0660 Part 102

### Rating data for approved types

Switching capacity			
Maximum motor rating			
Three-phase			
200 V 208 V		HP	Hinweis: Motorleistung in diesem Bereich nach Bemessungsstrom berechnen. Angegebene Werte nach NEC Table 430-150
230 V 240 V		HP	Hinweis: Motorleistung in diesem Bereich nach Bemessungsstrom berechnen. Angegebene Werte nach NEC Table 430-150
460 V 480 V		HP	Hinweis: Motorleistung in diesem Bereich nach Bemessungsstrom berechnen. Angegebene Werte nach NEC Table 430-150
575 V 600 V		HP	Hinweis: Motorleistung in diesem Bereich nach Bemessungsstrom berechnen. Angegebene Werte nach NEC Table 430-150
Short Circuit Current Rating, group protection		SCCR	
600 V High Fault			
SCCR (fuse)		kA	50

max. Fuse	A	600
SCCR (CB)	kA	50
max. CB	A	600

## Design verification as per IEC/EN 61439

Technical data for design verification			
Rated operational current for specified heat dissipation	$I_n$	A	0.4
Heat dissipation per pole, current-dependent	$P_{vid}$	W	0
Equipment heat dissipation, current-dependent	$P_{vid}$	W	5.22
Static heat dissipation, non-current-dependent	$P_{vs}$	W	0
Heat dissipation capacity	$P_{diss}$	W	0
Operating ambient temperature min.		°C	-25
Operating ambient temperature max.		°C	55
IEC/EN 61439 design verification			
10.2 Strength of materials and parts			
10.2.2 Corrosion resistance			Meets the product standard's requirements.
10.2.3 Verification of thermal stability of enclosures			
10.2.3.1 Verification of resistance of insulating materials to normal heat			Meets the product standard's requirements.
10.2.3.2 Verification of resistance of insulating materials to abnormal heat and fire due to internal electric effects			Meets the product standard's requirements.
10.2.3.3 Verification of resistance of insulating materials to abnormal heat and fire due to internal electric effects			Meets the product standard's requirements.
10.2.4 Resistance to ultra-violet (UV) radiation			Meets the product standard's requirements.
10.2.5 Lifting			Does not apply, since the entire switchgear needs to be evaluated.
10.2.6 Mechanical impact			Does not apply, since the entire switchgear needs to be evaluated.
10.2.7 Inscriptions			Meets the product standard's requirements.
10.3 Degree of protection of ASSEMBLIES			Does not apply, since the entire switchgear needs to be evaluated.
10.4 Clearances and creepage distances			Meets the product standard's requirements.
10.5 Protection against electric shock			Does not apply, since the entire switchgear needs to be evaluated.
10.6 Incorporation of switching devices and components			Does not apply, since the entire switchgear needs to be evaluated.
10.7 Internal electrical circuits and connections			Is the panel builder's responsibility.
10.8 Connections for external conductors			Is the panel builder's responsibility.
10.9 Insulation properties			
10.9.2 Power-frequency electric strength			Is the panel builder's responsibility.
10.9.3 Impulse withstand voltage			Is the panel builder's responsibility.
10.9.4 Testing of enclosures made of insulating material			Is the panel builder's responsibility.
10.10 Temperature rise			The panel builder is responsible for the temperature rise calculation. Eaton will provide heat dissipation data for the devices.
10.11 Short-circuit rating			Is the panel builder's responsibility. The specifications for the switchgear must be observed.
10.12 Electromagnetic compatibility			Is the panel builder's responsibility. The specifications for the switchgear must be observed.
10.13 Mechanical function			The device meets the requirements, provided the information in the instruction leaflet (IL) is observed.

## Technical data ETIM 7.0

Low-voltage industrial components (EG000017) / Motor protection circuit-breaker (EC000074)			
Electric engineering, automation, process control engineering / Low-voltage switch technology / Circuit breaker (LV < 1 kV) / Motor protection circuit-breaker (ecl@ss10.0.1-27-37-04-01 [AGZ529016])			
Overload release current setting	A		0.25 - 0.4
Adjustment range undelayed short-circuit release	A		6.2 - 6.2
With thermal protection			Yes
Phase failure sensitive			Yes
Switch off technique			Thermomagnetic
Rated operating voltage	V		690 - 690
Rated permanent current $I_u$	A		0.4
Rated operation power at AC-3, 230 V	kW		0.06
Rated operation power at AC-3, 400 V	kW		0.09
Type of electrical connection of main circuit			Screw connection

Type of control element		Push button
Device construction		Built-in device fixed built-in technique
With integrated auxiliary switch		No
With integrated under voltage release		No
Number of poles		3
Rated short-circuit breaking capacity Icu at 400 V, AC	kA	50
Degree of protection (IP)		IP20
Height	mm	93
Width	mm	45
Depth	mm	90.5

## Approvals

Product Standards		IEC/EN 60947-4-1; UL 60947-4-1; CSA - C22.2 No. 60947-4-1-14; CE marking
UL File No.		E36332
UL Category Control No.		NLRV
CSA File No.		165628
CSA Class No.		3211-05
North America Certification		UL listed, CSA certified
Specially designed for North America		No
Suitable for		Branch circuit: Manual type E if used with terminal, or suitable for group installations

## Characteristics

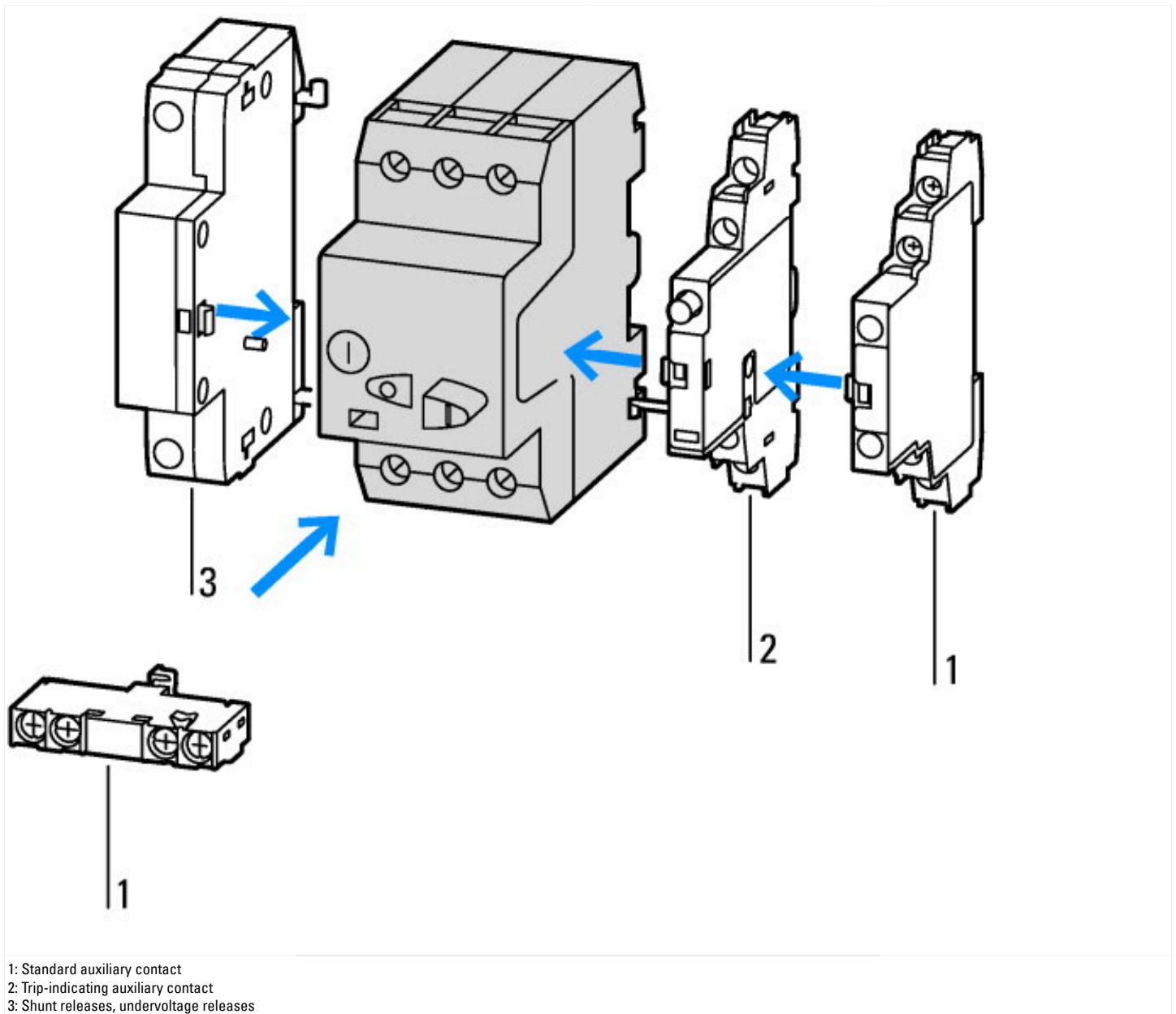

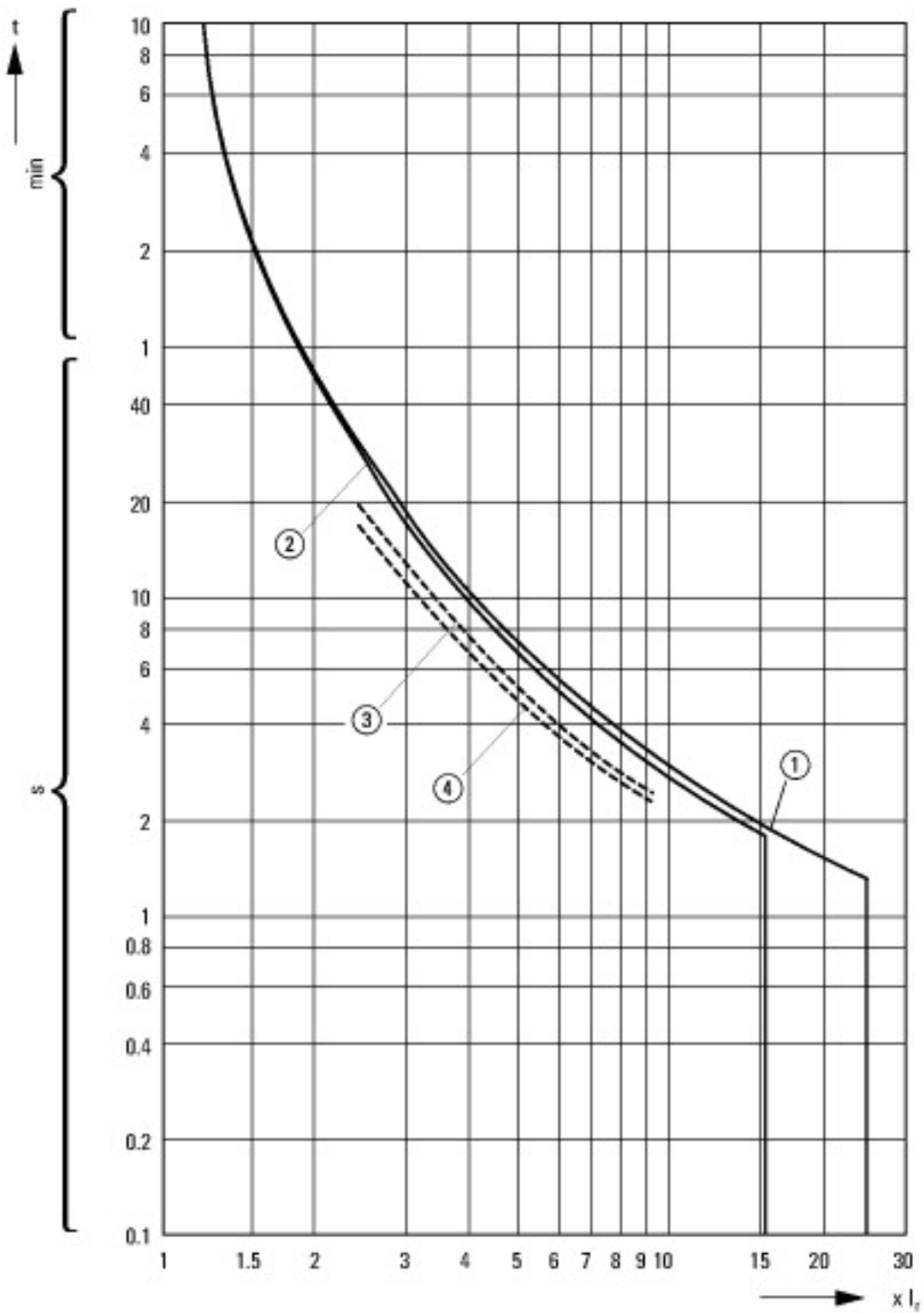

Tripping characteristics motor circuit breaker PKZM0-..., PKZM01

- 1: Minimum level, 3-phase
- 2: Maximum level, 3-phase
- 3: Minimum marker, 2-phase
- 4: Highest marker, 2-phase



Let-through current



① 1 half-cycle  
Let-through energy



## Dimensions



## Additional product information (links)

<b>IL03407011Z (AWA1210-1925) Motor-protective circuit-breaker</b>	
IL03407011Z (AWA1210-1925) Motor-protective circuit-breaker	<a href="ftp://ftp.moeller.net/DOCUMENTATION/AWA_INSTRUCTIONS/IL03407011Z2018_04.pdf">ftp://ftp.moeller.net/DOCUMENTATION/AWA_INSTRUCTIONS/IL03407011Z2018_04.pdf</a>
<b>'IL03402034Z (AWA121-1945) Motor-protective circuit-breaker, Starter</b>	
'IL03402034Z (AWA121-1945) Motor-protective circuit-breaker, Starter	<a href="ftp://ftp.moeller.net/DOCUMENTATION/AWA_INSTRUCTIONS/IL03402034Z2018_06.pdf">ftp://ftp.moeller.net/DOCUMENTATION/AWA_INSTRUCTIONS/IL03402034Z2018_06.pdf</a>
Schaltvermögen	<a href="https://de.ecat.eaton.com/flip-cat/?edition=MOTCONT1_DE#page_3/45">https://de.ecat.eaton.com/flip-cat/?edition=MOTCONT1_DE#page_3/45</a>
Motor starters and "Special Purpose Ratings" for the North American market	<a href="http://www.eaton.eu/ecm/groups/public/@pub/@europe/@electrical/documents/content/pct_3258146.pdf">http://www.eaton.eu/ecm/groups/public/@pub/@europe/@electrical/documents/content/pct_3258146.pdf</a>
Busbar Component Adapters for modern Industrial control panels	<a href="http://www.moeller.net/binary/ver_techpapers/ver960en.pdf">http://www.moeller.net/binary/ver_techpapers/ver960en.pdf</a>